

Climate Change Research Programme (CCRP) 2007-2013 Report Series No. 15



*Carbon Restore –
The Potential of Restored
Irish Peatlands for Carbon
Uptake and Storage*

Environmental Protection Agency

The Environmental Protection Agency (EPA) is a statutory body responsible for protecting the environment in Ireland. We regulate and police activities that might otherwise cause pollution. We ensure there is solid information on environmental trends so that necessary actions are taken. Our priorities are protecting the Irish environment and ensuring that development is sustainable.

The EPA is an independent public body established in July 1993 under the Environmental Protection Agency Act, 1992. Its sponsor in Government is the Department of the Environment, Community and Local Government.

OUR RESPONSIBILITIES

LICENSING

We license the following to ensure that their emissions do not endanger human health or harm the environment:

- waste facilities (e.g., landfills, incinerators, waste transfer stations);
- large scale industrial activities (e.g., pharmaceutical manufacturing, cement manufacturing, power plants);
- intensive agriculture;
- the contained use and controlled release of Genetically Modified Organisms (GMOs);
- large petrol storage facilities;
- waste water discharges.

NATIONAL ENVIRONMENTAL ENFORCEMENT

- Conducting over 2,000 audits and inspections of EPA licensed facilities every year.
- Overseeing local authorities' environmental protection responsibilities in the areas of - air, noise, waste, waste-water and water quality.
- Working with local authorities and the Gardaí to stamp out illegal waste activity by co-ordinating a national enforcement network, targeting offenders, conducting investigations and overseeing remediation.
- Prosecuting those who flout environmental law and damage the environment as a result of their actions.

MONITORING, ANALYSING AND REPORTING ON THE ENVIRONMENT

- Monitoring air quality and the quality of rivers, lakes, tidal waters and ground waters; measuring water levels and river flows.
- Independent reporting to inform decision making by national and local government.

REGULATING IRELAND'S GREENHOUSE GAS EMISSIONS

- Quantifying Ireland's emissions of greenhouse gases in the context of our Kyoto commitments.
- Implementing the Emissions Trading Directive, involving over 100 companies who are major generators of carbon dioxide in Ireland.

ENVIRONMENTAL RESEARCH AND DEVELOPMENT

- Co-ordinating research on environmental issues (including air and water quality, climate change, biodiversity, environmental technologies).

STRATEGIC ENVIRONMENTAL ASSESSMENT

- Assessing the impact of plans and programmes on the Irish environment (such as waste management and development plans).

ENVIRONMENTAL PLANNING, EDUCATION AND GUIDANCE

- Providing guidance to the public and to industry on various environmental topics (including licence applications, waste prevention and environmental regulations).
- Generating greater environmental awareness (through environmental television programmes and primary and secondary schools' resource packs).

PROACTIVE WASTE MANAGEMENT

- Promoting waste prevention and minimisation projects through the co-ordination of the National Waste Prevention Programme, including input into the implementation of Producer Responsibility Initiatives.
- Enforcing Regulations such as Waste Electrical and Electronic Equipment (WEEE) and Restriction of Hazardous Substances (RoHS) and substances that deplete the ozone layer.
- Developing a National Hazardous Waste Management Plan to prevent and manage hazardous waste.

MANAGEMENT AND STRUCTURE OF THE EPA

The organisation is managed by a full time Board, consisting of a Director General and four Directors.

The work of the EPA is carried out across four offices:

- Office of Climate, Licensing and Resource Use
- Office of Environmental Enforcement
- Office of Environmental Assessment
- Office of Communications and Corporate Services

The EPA is assisted by an Advisory Committee of twelve members who meet several times a year to discuss issues of concern and offer advice to the Board.

EPA Climate Change Research Programme 2007–2013

***Carbon Restore* – The Potential of Restored
Irish Peatlands for Carbon Uptake and Storage**

The Potential of Peatlands for Carbon Sequestration

(2007-CCRP-1.6)

CCRP Report

Prepared for the Environmental Protection Agency

by

University College Dublin

Authors:

**David Wilson,¹ Florence Renou-Wilson,¹ Catherine Farrell,²
Craig Bullock³ and Christoph Müller¹**

¹ School of Biology and Environmental Science, University College Dublin,

² Bord na Móna, ³ School of Geography, Planning and Environmental Policy

ENVIRONMENTAL PROTECTION AGENCY
An Ghníomhaireacht um Chaomhnú Comhshaoil
PO Box 3000, Johnstown Castle, Co. Wexford, Ireland

Telephone: +353 53 916 0600 Fax: +353 53 916 0699
Email: info@epa.ie Website: www.epa.ie

ACKNOWLEDGEMENTS

This report is published as part of the Climate Change Research Programme 2007–2013. The programme is financed by the Interdepartmental Committee for Strategy for Science, Technology and Innovation and the Department of Environment, Heritage and Local Government. It is administered on behalf of the Department of the Environment, Heritage and Local Government by the Environmental Protection Agency which has the statutory function of co-ordinating and promoting environmental research.

The authors would like to thank Phillip O’Brien and Hans Joosten for insightful comments on earlier drafts. We would also like to thank Simone Hepp, Burkart Dietrich, Anne Killion and Eeva-Stiina Tuittila. Grateful thanks to Bord na Móna for the use of the study site at Bellacorick, Co. Mayo.

DISCLAIMER

Although every effort has been made to ensure the accuracy of the material contained in this publication, complete accuracy cannot be guaranteed. Neither the Environmental Protection Agency nor the author(s) accept any responsibility whatsoever for loss or damage occasioned or claimed to have been occasioned, in part or in full, as a consequence of any person acting, or refraining from acting, as a result of a matter contained in this publication. All or part of this publication may be reproduced without further permission, provided the source is acknowledged.

The EPA CCRP Programme addresses the need for research in Ireland to inform policymakers and other stakeholders on a range of questions in relation to environmental protection. These reports are intended as contributions to the necessary debate on the protection of the environment.

EPA CCRP PROGRAMME 2007–2013

Published by the Environmental Protection Agency, Ireland

ISBN: 978-1-84095-436-4

Price: Free

Online version

Details of Project Partners

Professor Christoph Müller

University College Dublin School of Biology and Environmental Resource

Agriculture & Food Science Centre

University College Dublin

Belfield

Dublin 4

Ireland

Tel.: +353-01-716-7781

Email: christoph.mueller@ucd.ie

Table of Contents

Acknowledgements	ii
Disclaimer	ii
Details of Project Partners	iii
Executive Summary	vii
1 Introduction	1
1.1 Background	1
1.2 Literature Review	2
1.3 Aims/Objectives	8
2 Materials and Methods	9
2.1 Study Site	9
2.2 Environmental Variables	10
2.3 Vegetation Analysis	10
2.4 Greenhouse Gas Flux Measurements	11
2.5 Greenhouse Gas Flux Modelling Methods	12
2.6 Reconstruction of Annual CO ₂ -C Balance	12
2.7 Reconstruction of Annual CH ₄ -C	13
2.8 Global Warming Potential Calculations	13
2.9 Economic Analyses	13
3 Results	14
3.1 Environmental Variables	14
3.2 Greenhouse Gas Flux Modelling	15
3.3 Annual CO ₂ -C Balance	16
3.4 Annual CH ₄ -C Balance	17
3.5 Global Warming Potential for the Study Site	18
3.6 Economic Analyses	19
4 Discussion and Conclusions	20

5 Observations and Recommendations	23
References	24
Acronyms and Annotations	32

Executive Summary

Industrial cutaway peatlands are highly degraded ecosystems that release significant quantities of carbon dioxide (CO₂) to the atmosphere annually. Their restoration offers the potential to reduce CO₂ emissions and to re-establish the carbon (C) sink function characteristic of natural peatlands. In this study, CO₂, methane (CH₄) and nitrous oxide (N₂O) fluxes were quantified over a 12-month period (1 January to 31 December 2009) at a rewetted industrial cutaway peatland at Bellacorick, Co. Mayo.

The site was restored in 2003, and this has resulted in a persistently high water table level throughout the study site and the extensive recolonisation of the former bare peat substrate by a range of vascular and moss vegetation. These include: (i) soft-rush-*Sphagnum* moss-dominated communities, (ii) *Sphagnum* moss-dominated communities, (iii) bog cotton-dominated communities, (iv) bare peat and (v) open water.

For the period of the study, the vegetated communities were net annual CO₂-C sinks, sequestering an average 279±246g C m⁻² yr⁻¹. Conversely, they were also significant net annual CH₄-C sources of 10.1±3.6g C m⁻² yr⁻¹. The bare-peat and open-water areas were net CO₂-C sources, releasing 40 and 53g C m⁻² yr⁻¹ respectively to the atmosphere. N₂O emissions were negligible throughout the study period. Calculation of the global warming potential (GWP, 100-year horizon) showed that the soft-rush-*Sphagnum* and bog cotton communities were net GHG sinks (i.e. causing a potential cooling effect on the climate). In contrast, the *Sphagnum* moss-bog cotton communities, bare-peat and open-water areas were net GHG sources (i.e. causing a potential net warming impact on the climate).

The current project assessed the potential economic value of restoration in terms of avoided losses and gains of C (€/tonne CO₂-eq ha⁻¹) through the use of a number of timeline scenarios. These followed the peatland from the cessation of peat extraction (T_{zero}), through rewetting (T₁) and on to the present day (T_{present}). The

results show that in the period T₁ to T_{present}, an estimated 75 tonnes CO₂-eq ha⁻¹ was mitigated by the restoration actions at Bellacorick – resulting in an estimated value of €1506 ha⁻¹ in avoided losses. In addition, net C sequestration at the peatland during the 12-month period of this study (T_{present}) was worth an estimated €118 ha⁻¹ yr⁻¹.

The results from this study indicate that restoration at Bellacorick has been successful with regard to re-establishing the C sink function. This observation highlights the potential use of restored industrial cutaway peatlands for C offsetting. However, there are a number of caveats. Firstly, studies elsewhere have shown that inter-annual variation in GHG fluxes is a characteristic feature of peatlands in general. As such, care should be taken in interpreting the results presented in this report as they represent a single 12-month period only. Secondly, the ongoing dynamic changes in vegetation composition observed at the study site may lead to a similar level of change in GHG fluxes in the future. Thirdly, while the results from this study indicate that some aspects of ecological functioning have been restored at Bellacorick, it may not be possible to recreate conditions to the same extent in other degraded peatlands.

Given that 30,000ha of industrial cutaways may be available for restoration/wetland creation over the next 20 years, it is critical that appropriate GHG management plans are in place prior to the cessation of peat extraction. The plans should include a detailed assessment of the physical and nutrient characteristics of each cutaway site and should seek to identify the best approach for the avoidance of GHG emissions in the first instance (e.g. drain blocking, shallow inundation, etc.). The plans should also identify the potential of each cutaway site in regard to C sequestration in the medium/long term, and highlight the criteria required to achieve those objectives.

1 Introduction

1.1 Background

The most recent assessment report from the Intergovernmental Panel for Climate Change (IPCC) stated that 'most of the observed increase in global average temperatures since the mid-twentieth century is *very likely* due to the observed increase in anthropogenic greenhouse gas (GHGs) concentrations' (IPCC 2007, authors' emphasis). The atmospheric concentration of the GHGs – carbon dioxide (CO₂), methane (CH₄) and nitrous oxide (N₂O) – has increased from their pre-industrial values by 35, 148 and 18% respectively. This is primarily a result of human activities – such as fossil-fuel burning, land-use change and agriculture (IPCC 2007). Climate models predict that at the current rate of GHG emissions a significant increase in the global average temperature can be expected over the next century, concomitant with reduced snow and ice cover, sea-level rises and an increase in extreme weather events (IPCC 2007).

Peatlands play a major role in the global carbon (C) cycle and subsequent regulation and maintenance of the global climate (Vasander and Kettunen 2006, Dise 2009). There is an estimated 270 to 455 billion tonnes of C stored in boreal and sub-arctic peatlands (Sjörs 1980, Gorham 1991, Turunen *et al.* 2002), and a further 83 billion tonnes may be stored within tropical peatlands (Rieley *et al.* 2008). The ability of peatlands to continue to actively remove and store atmospheric C and thereby act as a buffer to climate change is highly dependent on the degradation status of the individual peatland.

Damaged peatlands are a significant source of CO₂ to the atmosphere (Page *et al.* 2002, Waddington *et al.* 2002, Wilson 2008, Joosten 2009) and the restoration of damaged peatland ecosystems has been suggested as one of the most cost-effective ways of reducing GHG emissions and mitigating the effects of climate change (Parish *et al.* 2008, Motherway and Walker 2009). Over 80% of Irish peatlands have been damaged to some extent (Renou-Wilson *et al.* 2011). These range from peatlands that have undergone relatively minor damage,

and where some of the ecosystem functioning remains relatively intact (e.g. low-impact traditional hand-cut peat extraction in some blanket bogs) to peatlands that have undergone extreme damage and where much of ecosystem functioning has been destroyed (e.g. industrial cutaway peatlands). In the latter category, restoration of the main ecosystem functions, in particular the ability to actively sequester and store C, presents a major challenge. While the rewetting of the industrial peatland and subsequent recolonisation by desirable plant species have been shown to lead to a reduction in CO₂ emissions (Waddington and Warner 2001, Drösler 2005) and a return to C sequestration in other countries (Tuittila *et al.* 1999), knowledge in Ireland as to how such remedial management actions may affect C gas exchange in these highly degraded peatlands is limited.

Currently, Annex 1 Parties to the United Nations Framework Convention on Climate Change (UNFCCC) and the Kyoto Protocol are obliged to prepare annual National Inventory Reports (NIR), detailing GHG emissions and removals from six different sectors: (i) energy, (ii) industrial processes, (iii) solvents and other product use, (iv) agriculture, (v) land use, land use change and forestry (LULUCF) and (vi) waste. Greenhouse gas fluxes from natural peatlands are not reported because the fluxes are not anthropogenic in origin (O'Brien 2007). Emissions associated with peat combustion are recognised and are reported under the energy sector with emissions from industrial peatlands reported under LULUCF (Wetlands: Category 5.D). Although the rewetting of drained peatlands as a climate-mitigation action has been addressed in the UNFCCC and IPCC, it has not yet led to clear implementation rules or obligations. Because of the lack of scientific data, no good-practice guidance has been given for assessing GHG fluxes on rewetted organic soils (IPCC 2006, O'Brien 2007). However, in June 2010, the Subsidiary Body for Scientific and Technological Advice (SBSTA, i.e. the body that provides technical advice to the UNFCCC), took a decision to 'clarify, improve and update information' in regard to methodologies to

account for information gaps from wetland uses not currently covered. These include drained wetlands, the rewetting of previously drained wetlands and the restoration of wetlands (SBSTA 2010). This decision suggests an acknowledgement that emissions from drained wetlands are significant and that rewetting peatlands is an important contribution to decreasing GHG emissions. At the UNFCCC meeting in Cancún (December 2010), unanimity was reached among LULUCF negotiators on the definition and content of a new activity under the Kyoto Protocol, called 'rewetting and drainage'. The definition of the proposed new activity is:

Rewetting and drainage is a system of practices for rewetting and draining on land with organic soil that covers a minimum area of 1 ha. The activity applies to all lands that have been drained and/or rewetted since 1990 and that are not accounted for under any other activity as defined in this appendix, where drainage is the direct human-induced lowering of the soil water table and rewetting is the direct human-induced partial or total reversal of drainage.

(Document: FCCC/KP/AWG/2010/CRP.4/Rev.4)

Furthermore, the utilisation of rewetted peatlands in voluntary C offset projects has recently been made possible by the Verified Carbon Standard Program (VCS) in the Peatland Rewetting and Conservation module (PRC) of its new Agriculture, Forestry and Other Land Uses (AFOLU) Guidelines (8 March, 2011).

Implicit within these objectives is that both the avoided GHG losses and C sequestered by the new rewetted ecosystems are 'measurable, reportable and verifiable' (Joosten and Couwenberg 2009). Therefore, it is essential that the potential of these new ecosystems to (i) avoid GHG emissions and (ii) sequester C is assessed and quantified properly in light of possible accounting changes in the post Kyoto Protocol commitment period (2012 onwards) and in view of possible inclusion in C offset projects.

1.2 Literature Review

Box 1.1. Note on terms used in this report

CO₂-C represents the carbon atom contained within the CO₂ molecule. In terms of the overall molecular weight of CO₂, the carbon atom accounts for 12/44 or 27%. Thus, a multiplier of 3.667 is required in order to convert CO₂-C values to CO₂.

CH₄-C represents the carbon atom contained within the CH₄ molecule. In terms of the overall molecular weight of CH₄, the carbon atom accounts for 12/16 or 75%. Thus, a multiplier of 1.334 is required in order to convert CH₄-C values to CH₄.

N₂O-N represents the nitrogen atoms contained within the N₂O molecule. In terms of the overall molecular weight of N₂O, the nitrogen atoms accounts for 28/44 or 64%. Thus, a multiplier of 1.571 is required in order to convert N₂O-N values to N₂O.

Negative gas flux values indicate an uptake by the peatland and positive gas flux values indicate a loss from the peatland to the atmosphere.

1.2.1 Greenhouse Gas Exchange in Natural Peatlands

Natural peatlands, that is peatlands that are intact and undamaged, are able to act as long-term C sinks, primarily as a result of a persistently high water table (WT) within the peat (Belyea and Clymo 2001, Mäkilä *et al.* 2001, Belyea and Malmer 2004, Lund *et al.* 2010), which creates conditions whereby the amount of CO₂ fixed by the peatland vegetation during photosynthesis (P_g) is greater than that released during ecosystem respiration (R_{ECO}). NEE has a strong diurnal and seasonal variation (Nieveen *et al.* 1998, Lafleur *et al.* 2001, Vasander and Kettunen 2006), with the highest values during daytime in the summer months (Wilson *et al.* 2007a). However, numerous studies have reported strong inter-annual variations in NEE (Shurpali *et al.* 1995, Roulet *et al.* 2007, Worrall *et al.* 2009a, Koehler *et al.* 2010, Sottocornola and Kiely 2010), and a peatland can switch easily from being an annual CO₂

sink to an annual CO₂ source in consecutive years (Shurpali *et al.* 1995), although over the medium to long term, as evidenced by the accumulated peat, they are net C sequesters. The magnitude of the C sink/source function is determined to a large extent by ecosystem respiration (Charman 2002). Composed of two respiratory processes – autotrophic (plant) and heterotrophic (microbial) – ecosystem respiration has been shown to be very sensitive to changes in both soil temperature (Lafleur *et al.* 2005, Laine *et al.* 2006, Wilson 2008) and fluctuations in the WT (Laine *et al.* 2007a, Riutta *et al.* 2007b). When the WT level is at or close to the surface of the peatland, decomposition of organic matter (plant litter and root exudates) within the peat profile is constrained by the absence of oxygen and so CO₂ production is relatively small. When the

WT drops (either through drought or damage to the peatland), the magnitude of the soil CO₂ component increases significantly as a consequence of higher rates of decomposition of the peat (Silvola *et al.* 1996, Alm *et al.* 1999, Wilson 2008).

While CO₂ is the largest component of the peatland C balance, CH₄ fluxes are also significant. Natural peatlands are a major source of atmospheric CH₄ (Bubier *et al.* 1993, Nykänen *et al.* 1998, Vasander and Kettunen 2006, Laine *et al.* 2007b) releasing an estimated 20–65 Terragrams (Tg) CH₄ yr⁻¹ (Matthews and Fung 1987, Cao *et al.* 1998, Walter *et al.* 2001, Mikaloff Fletcher *et al.* 2004), which equates to approximately 4–11% of the total atmospheric burden of around 582 Tg CH₄ yr⁻¹ (IPCC 2007). CH₄ fluxes have

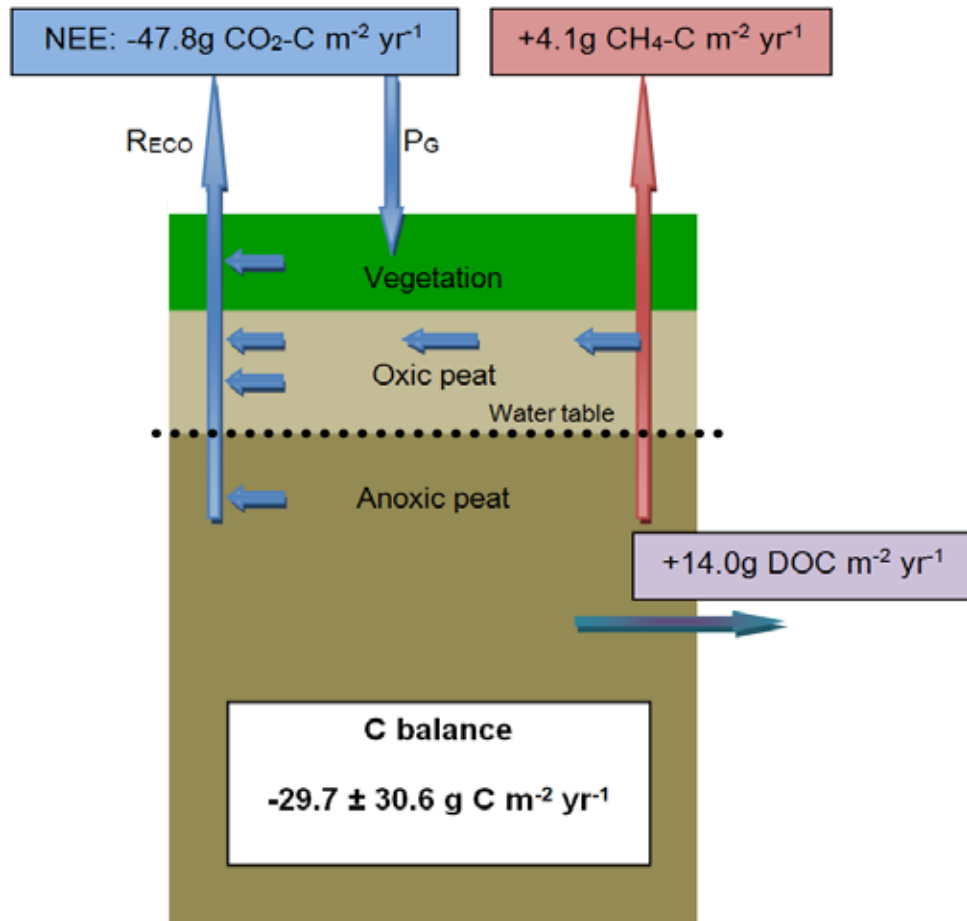

Figure 1.1 The carbon balance of a natural Atlantic blanket bog at Co. Kerry, Ireland. Values adapted from Koehler *et al.* (2010). Negative values indicate a net uptake of C by the peatland and positive values indicate a net loss of C to the atmosphere.

been shown to be highly correlated to the position of the WT, with higher emissions recorded when the WT is close to the surface of the soil (Roulet *et al.* 1992, Nykänen *et al.* 1998, Bubier *et al.* 2005, Laine *et al.* 2007b, Couwenberg *et al.* 2011). CH₄ fluxes are also strongly influenced by the vegetation composition of the peatland, in particular aerenchymatic plant species, such as sedges (Joabsson *et al.* 1999, Ström *et al.* 2003, Strack *et al.* 2006). Because of their unique cellular structure, these plant species facilitate the movement of CH₄ from the anoxic peat directly to the atmosphere, bypassing the oxic peat zone where CH₄ is oxidised to CO₂. Losses of dissolved organic carbon (DOC) and particulate organic carbon (POC) from the peatland in run-off to adjacent water courses have been shown to be considerable (Fig. 1.1, Worrall *et al.* 2003, Worrall and Burt 2005, Roulet *et al.* 2007, Jager *et al.* 2009, Koehler *et al.* 2009, Worrall *et al.* 2009a) and may be accentuated by future climate warming (Freeman *et al.* 2001). Studies have shown that fluxes of N₂O from natural peatlands are generally negligible (Martikainen *et al.* 1995, Nykänen *et al.* 1996), although significant N₂O emissions have been reported during periods of drought and during the subsequent rise in WT levels within the peatland (Goldberg *et al.* 2010).

1.2.2 Industrial Peat Extraction

Connolly and Holden (2009) have estimated that peat soils currently cover around 20% of the land area in the Republic of Ireland, although only a small percentage of this area is in a natural or intact condition (Douglas *et al.* 2008). In over 80% of the peatland area, the main ecosystem functions characteristic of intact natural peatlands (hydrology, vegetation dynamics, C cycling etc.) have been seriously impaired as a consequence of land-use changes, for example agricultural reclamation, forestry and peat extraction (Renou-Wilson *et al.* 2011).

In recent times, the majority of peat has been extracted using either small-scale mechanisation (e.g. tractor mounted hoppers) or more large-scale industrial processes (milled peat methods). Since 1949, most of the peat has been extracted industrially by the semi-state body Bord na Móna, which currently removes around 4 million tonnes of peat per year (<http://www.bnm.ie>). Around 3 million tonnes of the extracted peat is burned in the peat-fired power stations at Lough Ree, West Offaly and Edenderry, or made into peat briquettes for use in the residential sector.

The remainder of the peat (around 1 million tonnes) is utilised in horticultural products.

Industrial peat extraction has a number of fundamental impacts on peatland ecosystem functioning. In order to facilitate the use of heavy machinery on the peatland during the peat-extraction process, drainage ditches are installed at 15m intervals. This results in a lowering of the WT and leads to increased oxidation of the peat substrate, and a rise in soil CO₂ emissions (Holmgren *et al.* 2006). Subsequent removal of the vegetation and upper fibrous layers of peat removes the CO₂ fixing capacity (i.e. photosynthesis) of the peatland (Waddington and Price 2000) and the ecosystem is transformed from an annual CO₂ sink and CH₄ source (natural peatland) to a large CO₂ source and reduced CH₄ source (Table 1.1), although CH₄ emissions from drainage ditches may still be very significant (Nykänen *et al.* 1996, Sundh *et al.* 2000, Waddington *et al.* 2009). N₂O emissions, considered negligible in natural peatlands, may increase significantly following drainage (Martikainen *et al.* 1995, Augustin *et al.* 1998), particularly in nutrient-rich peatlands (Kasimir-Klemetsson *et al.* 1997, Schils *et al.* 2008).

In Ireland, industrial peat extraction typically removes around 15–22.5cm of peat per year (<http://www.bnm.ie>) and continues until either (i) the underlying mineral substrate is reached, (ii) fossilised trees are encountered within the peat profile or (iii) it proves to be uneconomic to pump the drainage water out of the peatland (Farrell and Doyle 2003). Following the cessation of industrial peat extraction, the peatland is designated a 'cutaway' and is potentially available for other uses (Table 1.2). In Ireland, these uses have included agriculture and commercial forestry (now limited), and natural re-generation of wetlands (open water, fen, reedbed and acidic wetlands) and woodland (birch and willow scrub) habitats. Studies have shown that GHG dynamics vary considerably across the various land-use options. For example, Byrne *et al.* (2007a) observed that an afforested cutaway was a C sink of 1.25t CO₂-C ha⁻¹ yr⁻¹ (4.57 t CO₂eq. ha⁻¹ yr⁻¹) but that a naturally regenerated cutaway dominated by birch and willow was a large C source of 5.25t CO₂-C ha⁻¹ yr⁻¹ (19.22 t CO₂eq. ha⁻¹ yr⁻¹) (Byrne *et al.* 2007b). Similarly, the costs associated with development of these new land uses vary considerably (Table 1.2). Relatively low costs are attached to

Table 1.1. Greenhouse gas fluxes (CO₂-C, CH₄-C and N₂O-N; tonnes ha⁻¹ yr⁻¹) from peat-extraction areas (non-vegetated bare peat). Positive values indicate a flux from the peatland to the atmosphere.

	CO ₂ -C	CH ₄ -C	N ₂ O-N	Reference source
Location	Tonnes ha ⁻¹ yr ⁻¹	Tonnes ha ⁻¹ yr ⁻¹	Tonnes ha ⁻¹ yr ⁻¹	
Finland	2.40	0.002	0.0002	Nykänen <i>et al.</i> 1996
Sweden	0.55–2.73	0.003–0.034 ^a	–	Sundh <i>et al.</i> 2000
Canada	3.98 ^b	–	–	Waddington and Warner 2001
Canada	0.88–3.97 ^b	–	–	Waddington <i>et al.</i> 2002
Canada	3.02	0.014	–	Cleary <i>et al.</i> 2005
Sweden	2.73 ^c	0–0.02	0–0.016	Holmgren <i>et al.</i> 2006
Finland	3.16	0.004	0	Holmgren <i>et al.</i> 2006
Ireland	1.9–3.5	-0.001	–	Wilson <i>et al.</i> 2007
Finland	1.89–11.18	0.054	0.002	Alm <i>et al.</i> 2007a
IPCC ^d	0.2–1.1	0	0.001–0.002	Penman <i>et al.</i> 2003

a Includes emissions from drainage ditches, b May–August period only, c Includes emissions from stockpiles, d IPCC default emission factor for nutrient poor and nutrient rich industrial peatlands (CO₂-C and N₂O-N) and for drained organic soils (CH₄-C).

Table 1.2. Future dominant land-use/habitats on Bord na Móna cutaway bogs (post-peat production) based on current estimates and evidence of vegetation succession patterns and estimated cost of establishment.

Land use	Present areas [§] (ha)	Future areas [§] (ha)	Cost (€ ha ⁻¹)
Afforestation	4,000	5-10,000	3,200*
Birch woodland (scrub)	4,000	20,000	120
Alkaline wetland	5,000	20,000	250
Acid wetland	6,500	20,000	400

§ Bord na Móna internal reports, * Cost covered by grant assistance.

birch woodland as the ecosystem usually develops spontaneously with minimal human impact. The cost of wetland creation is somewhat higher as mechanical diggers/bulldozers are used to block drainage ditches and landscape the peatland. The largest costs are associated with afforestation of the cutaway peatland (cultivation, fencing, planting, weed control etc.) but

grant subsidies are available. The costs associated with restoration of afforested peatlands are generally higher (€2,194 to €4,378 ha⁻¹; Coillte EU LIFE project), and the cost of rehabilitating peatlands damaged by domestic turf extraction is likely to be substantial given that the peatland may have to be purchased from the landowner in the first place.

1.2.3 Restoration of Industrial Cutaway Peatlands

The term *restoration* is often associated with efforts to return a damaged ecosystem to the state that existed immediately prior to the degrading action. In the case of industrial cutaway peatlands in Ireland, this is clearly impossible as (a) a large volume of peat has been extracted industrially and (b) the peat remaining following the cessation of peat extraction is unsuitable for supporting the vegetation communities characteristic of climax peatland ecosystems (Wheeler and Shaw 1995, Farrell and Doyle 2003). However, restoration can also imply that the objective is to return the ecosystem to some point along its original developmental trajectory, which was curtailed when peat extraction began (Vasander *et al.* 2003). In this regard, the 're-establishment of the self-regulatory mechanisms necessary to sustain peat growth without further human interventions' (Quinty and Rochefort 2003) is an obvious goal. Restoration of cutaway peatlands presents considerable difficulties. Initial vegetation colonisation of the peat substrate following the cessation of peat extraction can be a slow process (Salonen *et al.* 1992, Quinty and Rochefort 2003) primarily as a result of the absence of typical peatland plant species on the surface (Curran and MacNaeidhe 1986) and in the seed bank (Huopalainen *et al.* 1998), and the distance of residual plant populations from the cutaway (Campbell *et al.* 2003). Plant establishment and survival are made more difficult by the conditions that may exist in the upper layers of the peat body. These conditions typically include unsuitable nutrient status (Wind-Mulder *et al.* 1996), instability of the peat surface (Campbell *et al.* 2002), WT fluctuations (Price 1997), evaporative losses (Waddington and Price 2000, Van Seters and Price 2001) and high peat temperatures in mid-summer, which can be more of a challenge in climatic regions with more extreme weather events than Ireland.

Active management methods are employed to create the conditions that will allow the restoration process to develop (Quinty and Rochefort 2003). This approach generally involves two components. Firstly, the WT is raised by blocking the drainage ditches and creating a bund or ridge to retain the water within the peatland (Wheeler and Shaw 1995). These measures are necessary to create suitable conditions (e.g. a persistently high WT) for the establishment of desirable peatland vegetation communities (Charman 2002)

and can have an immediate effect in areas where vegetation is already established (Farrell and Doyle 2003). For example, Tuittila *et al.* (1999) reported a significant increase in the cover of *Eriophorum vaginatum* following the blocking of drainage ditches in an abandoned cutaway peatland in southern Finland. Similarly, Tuittila *et al.* (2000b) noted a rapid succession towards a closed mire vegetation when the WT was raised close to or above the soil surface. The second component involves the re-introduction of species that are characteristic of natural peatlands (Cooper and MacDonald 2000), in particular, peat-forming species such as *Sphagna* (Rochefort *et al.* 2002, Tuittila *et al.* 2003). 'Donor' peatlands have been used widely in Canada, whereby *Sphagna* are harvested from a nearby natural peatland and then spread on the damaged peatland. Re-establishment has been shown to be enhanced by the use of companion species, such as *Polytrichum commune* (Groeneveld *et al.* 2007) and *Eriophorum angustifolium* (Ferland and Rochefort 1997), by peat-surface topography manipulations that create a series of ridges and shallow basins that enhance conditions for *Sphagnum* establishment (Ferland and Rochefort 1997, Farrell and Doyle 2003, Campeau *et al.* 2004) and by fertilisation (Sottocornola *et al.* 2007). Farrell (2001) noted a rapid spread and establishment of *Sphagnum* species on industrial cutaway bog in Mayo following simple rewetting measures, with typical peatland species, such as *Sphagnum* mosses and sedges, such as *Eriophorum angustifolium*, establishing within relatively short timeframes (three to ten years).

In Ireland, a considerable amount of research on restoration and management of peatlands has been carried out over the last number of decades (e.g. Egan 1998, O'Connell 1998, Schouten 1998, Foss *et al.* 2001, Schouten 2002, Farrell and Doyle 2003, Delaney 2008, Malone and O'Connell 2009). This research has, in turn, been actively implemented at the peatland site level by governmental agencies, such as the National Parks and Wildlife Service (NPWS), non-governmental organisations, such as the Irish Peatland Conservation Council, semi-state bodies such as Coillte and Bord na Móna, and by private individuals. Restoration of damaged peatlands is very site specific and strongly influenced by a number of factors – for example, peatland type, the degradation status of the peatland (Farrell 2008) and topography (Wheeler and Shaw 1995). To date, around 11,000ha of acid and

alkaline wetlands have been created by Bord na Móna. As the post-industrial use of the cutaway is largely determined by the residual peat type, underlying soil type and drainage conditions (Renou *et al.* 2006), a further 30,000ha of cutaway peatland could be suitable for restoration/rehabilitation to wetlands over the next decades.

1.2.4 Greenhouse Gas Exchange in Restored Peatlands

Various studies have reported a reduction in the magnitude of CO₂ losses when the peatland was rewetted and vegetation became re-established (Waddington and Price 2000, Waddington and Warner 2001, Drösler 2005). Other studies have reported C gas dynamics similar to those of natural peatlands (i.e. CO₂ sink and CH₄ source) within a short time frame following active rewetting and recolonisation (Komulainen *et al.* 1998, Komulainen *et al.* 1999, Tuittila *et al.* 1999, Soini *et al.* 2009) or from spontaneous regeneration of the peatland (Bortoluzzi *et al.* 2006). In the period following rewetting, peat oxidation rates are low as a consequence of the anoxic soil conditions and most of the C sequestered is contained within the peatland biomass pool (leaves, stems, roots). Over longer time frames some studies have reported a decrease in the amount of CO₂ sequestered annually (Yli-Petäys *et al.* 2007). As the peatland biomass pool increases over time, it will eventually approach a steady-state C sequestration saturation point (Anderson *et al.* 2008). The accumulation of organic matter (and the C therein) in a new peat layer is typically much slower (Lucchese *et al.* 2010). Resumption of CH₄ emissions following rewetting has been widely reported (Tuittila *et al.* 2000a, Bortoluzzi *et al.* 2006, Waddington and Day 2007, Couwenberg 2009, Wilson *et al.* 2009), although in some cases emissions may be somewhat lower than from comparable natural peatlands (Komulainen *et al.* 1998, Drösler 2005). In general, N₂O emissions tend to decrease when a peatland is rewetted, as nitrate (NO₃⁻) is fully reduced to nitrogen (N₂) or by plant species out-competing the denitrifying microbes for the available nitrogen (Silvan *et al.* 2005, Glatzel *et al.* 2008, Roobroeck *et al.* 2010).

1.2.5 Global Warming Potential

The potential change in GHG fluxes (CO₂ + CH₄ + N₂O) following rewetting is important in terms of calculating the global warming potential (GWP) of the peatland. The

GWP methodology is used to compare the integrated radiative forcing, over a specified time horizon (e.g. 20, 100, 500 years), of one unit mass of gas relative to one unit mass of a reference gas (IPCC 2007). CO₂ is assigned a reference value of 1 and emissions of CH₄ and N₂O, for example, can be converted into CO₂-equivalents (CO₂-eq) by multiplying the emission rates (e.g. kg CH₄ ha⁻¹ yr⁻¹) by their GWP value (Box 1.2). The use of GWP methodology has been shown to be less than ideal for expressing the radiative forcing of peatlands as they do not emit isolated emission pulses but instead are sustained and persistent sinks or sources (Frolking *et al.* 2006).

Box 1.2. Atmospheric lifetimes and global warming potentials (GWP) relative to CO₂.

GHG	Lifetime (years)	GWP		
		20 years	100 years	500 years
CO ₂	Variable	1	1	1
CH ₄	12	72	25	7.6
N ₂ O	114	289	298	153

Source: adapted from IPCC 2007

As noted above, at any given time, natural peatlands may function as either a net GHG source or sink and therefore may produce a net warming (Drösler 2005, Bäckstrand *et al.* 2010, Drewer *et al.* 2010) or net cooling impact on the climate (Gorham 1991, Roulet *et al.* 2007, Dinsmore *et al.* 2010, Drewer *et al.* 2010, Koehler *et al.* 2010). The key drivers in this regard are: (i) the relative strength of either CO₂ or CH₄ fluxes during the particular developmental stage of the peatland (Frolking *et al.* 2006, Frolking and Roulet 2007) and (ii) the time horizon employed (Whiting and Chanton 2001, Drösler 2005). Drained peatlands have a strong net warming impact on the global climate as a consequence of (i) the large emissions of CO₂ associated with drainage and (ii) the removal of the vegetation to facilitate peat extraction (Cleary *et al.* 2005, Salm *et al.* 2009, Wilson *et al.* 2009). In contrast, studies to date have shown that rewetted peatlands may have either a net cooling (Bortoluzzi *et al.* 2006) or net warming impact (Drösler 2005, Yli-Petäys *et al.* 2007, Wilson *et al.* 2009, Waddington *et al.* 2010), determined primarily by the magnitude of CH₄ emissions.

1.2.6 Economic Analyses of Peatland Restoration

In recent years, a growing body of research has attempted to place an economic value on ecosystem services, such as biodiversity (Bullock *et al.* 2008a, Nijkamp *et al.* 2008, TEEB 2009). The prospective monetary value of wetland restoration in terms of C sequestration has been highlighted in numerous studies (Bullock *et al.* 2008b, Galatowitsch 2009, Reed *et al.* 2009, Worrall *et al.* 2009b), and the potential of restored wetlands to be used as C-offset projects has also been identified (Hansen 2009, Danone Fund for Nature 2010, Jaenicke *et al.* 2010, Jenkins *et al.* 2010).

A C offset is a reduction in GHG emissions (tonnes CO₂eq) or an increase in C sequestration that is achieved to compensate for (i.e. offset) GHG emissions occurring from other activities elsewhere (Broekhoff and Zyla 2008). Offsets can be purchased by countries, companies or individuals and the key criterion for an offset is that the GHG reduction it represents would not have happened anyway, that is, it is 'additional' to business-as-usual activity. For example, an individual could reduce the impact of CO₂ emissions from activities, such as driving their car, by purchasing offsets from an accredited project that is certified to reduce CO₂ by an equivalent amount.

Under the Kyoto Protocol, countries are required to limit or reduce their GHG emissions. The protocol includes market-based mechanisms, such as emissions trading (cap and trade) as a way of helping countries to meet their GHG targets. Under these mechanisms C is assigned a value and traded as a commodity. Currently, C can be traded on either the mandatory markets, which are closely associated with Kyoto Protocol compliance requirements or on the voluntary markets. The volume and price of C traded tend to be considerably higher on the mandatory markets than within the voluntary markets (Hamilton *et al.* 2010, Jenkins *et al.* 2010), but the voluntary markets are currently seen as the most promising in terms of selling C credits from peatland restoration, as opportunities for peatland rewetting C-offset projects under compliance markets, such as the Kyoto Protocol, will not be available before 2012¹ at the earliest.

One of the most important quality standards on the voluntary market is the Verified Carbon Standard (VCS),

1 The present commitment period for the Kyoto Protocol is 2008–2012.

which includes Agriculture, Forestry and Other Land Use (AFOLU) in the list of eligible project activities (VCS Association 2008). Originally, it had four categories: (i) Afforestation, Reforestation, Revegetation (ARR), (ii) Agricultural Land Management (ALM), (iii) Improved Forest Management (IFM), and (iv) Reduced Emissions from Deforestation and Degradation (REDD). However, new guidance for the development of peat rewetting or conservation methodologies under the VCS programme has recently been adopted and published (8 March 2011) under the new AFOLU category 'Peatland Rewetting and Conservation' (PRC) (www.v-c-s.org).

The use of restored peatlands for C offset projects is attractive in that it offers the prospect for C mitigation by (i) transforming an ecosystem that is a large C source (e.g. an industrial peatland) to one in which the C losses are reduced (avoided losses), and by (ii) increasing the amount of C that may be actively sequestered by the peatland. This has been demonstrated by Jaenicke *et al.* (2010) who estimated that the rewetting of a tropical peatland in Indonesia could result in avoided losses of around 25 tonnes CO₂ ha⁻¹ yr⁻¹. Similarly, Worrall *et al.* (2009b) demonstrated that, depending on the price of C used, successful restoration of the C sink function in upland peatlands in the United Kingdom could lead to a profit from C offsetting within 30 years.

1.3 Aims/Objectives

The aims of this EPA funded project were to:

- 1 Establish a study site at Bellacorick industrial cutaway peatland for the quantification of CO₂, CH₄ and N₂O fluxes, and related environmental variables;
- 2 Quantify CO₂, CH₄ and N₂O fluxes, and related environmental variables over a 12-month period at a number of microsites within the study site;
- 3 Model the C gas fluxes using linear and non-linear modelling techniques;
- 4 Provide an estimate of the C gas balance of the main microsites within the peatland;
- 5 Estimate the impact of climatic radiative forcing through the calculation of global warming potential (GWP) for each microsite;
- 6 Determine potential economic benefits accruing from restoration of damaged peatlands in regards to GHG fluxes.

2 Materials and Methods

2.1 Study Site

The study site was located at Bellacorick, Co. Mayo (54° 7' N, 9° 35' W). Formerly an Atlantic blanket bog, the site forms part of the much larger Oweninny bog complex (6,500ha). From 1960 to 2003, the peat was industrially extracted and used in the nearby Bellacorick power station for electricity generation.

Between 1996 and 2002, small-scale rehabilitation test areas were established at Belloacorick and, following the cessation of peat extraction in 2003, a larger-scale rehabilitation plan was implemented in a sequential fashion across the peatland (Bord na Móna 2003). This involved the use of bulldozers and excavators to block drains, create peat ridges to contain the water, and to landscape the peatland surface. This resulted in a number of significant impacts: (i) a rise in the WT

level over large areas of the peatland, (ii) the creation of areas of open water and (iii) the recolonisation of the bare peat substrate by a range of vascular and moss communities.

Initial re-colonisation was dominated by *Juncus effusus* (soft rush), which in turn facilitated the establishment of moss species, such as *Polytrichum commune* and *Sphagnum cuspidatum* (Farrell and Doyle 2003). In the wetter parts of the site, *Eriophorum angustifolium* (bog cotton) is found widely, either as a pure stand or in conjunction with *Sphagnum cuspidatum*. The areas of open water and bare peat are decreasing annually as a result of rapid re-colonisation. On the drier edges of the site and along the peat ridges, *Pinus contorta* (lodgepole pine), *Calluna vulgaris* (heather) and *Rhododendron ponticum* (rhododendron) are found.

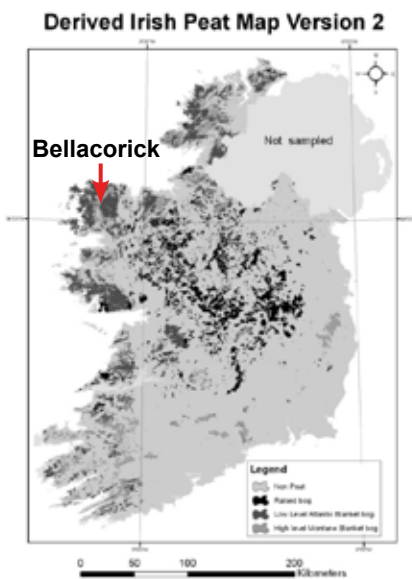

Location of the study site at Bellacorick, Co. Mayo.



Bellacorick industrial cutaway peatland in 2003. Photo by Catherine Farrell.



Bellacorick industrial cutaway peatland in 2009. Areas of bare peat and fossilised timber are still visible throughout the peatland. Photo by David Wilson.



Eriophorum angustifolium vegetation in full bloom at Bellacorick industrial cutaway peatland. Photo by David Wilson.



Juncus effusus and *Eriophorum angustifolium* vegetation at Bellacorick industrial cutaway peatland. Photo by David Wilson.

The residual depth of peat within the study site is around 50cm, with the peat composed mainly of highly humified cyperaceous peat overlying a glacial till substrate (Farrell and Doyle 2003). The pH ranges between 3.8 and 6.4 (Farrell and Doyle 2003) and the C:N ratio is 58.

The climate of the area is characterised by prevailing south-westerly winds and a mean annual rainfall of 1143mm. The mean monthly temperature ranges from 5.6°C in January to 14.1°C in August with a mean annual temperature of 9.3°C (Met Éireann – Belmullet Station, 1961–1990).

2.2 Environmental Variables

In order to examine the impact of rewetting on GHG exchange, 18 permanent sample plots were established within the Bellacorick site. Each sample plot consisted of a stainless steel collar (60 x 60cm) that was inserted to a depth of 30cm into the peat before the start of the study. Perforated polyvinyl chloride (PVC) pipes were inserted adjacent to each sample plot to measure WT position. Wooden boardwalks were built around the sample plots to minimise damage to the vegetation and to prevent compression of the peat during gas sampling. Data loggers (Micrologger Model 4R, Zetatec, Durham, UK) were established at the study site and recorded hourly soil temperatures at 5, 10 and 20cm depths. A weather station (WatchDog Model 2400, Spectrum Technologies Inc., Illinois, USA) was also established on the site and programmed to record

photosynthetic photon flux density (PPFD, $\mu\text{mol m}^{-2} \text{s}^{-1}$) every 10 minutes using Spec 8 Pro software (Spectrum Technologies Inc., Illinois, USA).

2.3 Vegetation Analysis

Following a visual survey of the site, sample plots were established within the main microsites ([Table 2.1](#)). These were:

- 1 *Juncus effusus*–*Sphagnum cuspidatum*-dominated communities (n=3);
- 2 *Sphagnum cuspidatum*-dominated communities (n=3);
- 3 *Eriophorum angustifolium*-dominated communities (n=3);
- 4 Bare peat (n=3);
- 5 Open water (n=6).

In order to incorporate the seasonal dynamics of the vegetation into C gas-exchange models, a green area index (GAI) was estimated for each sample plot (Wilson *et al.* 2007a). This involved measuring the green photosynthetic area of all vascular plants within the sample plot at monthly intervals. Moss coverage in the sample plot was estimated twice yearly. Species-specific model curves were applied to describe the phenological dynamics in vegetation. The models were summed (vascular and moss) to produce a GAI for each sample plot.

Table 2.1. Vegetation species composition within the studied microsites at Bellacorick, Co. Mayo.

Microsite	Dominant species	Others
<i>Juncus-Sphagnum</i>	<i>Juncus effusus</i> <i>Sphagnum cuspidatum</i>	<i>Polytrichum commune</i> <i>Hydrocotyle vulgaris</i> <i>Eriophorum angustifolium</i> <i>Juncus bulbosus</i> <i>Sphagnum capillifolium</i>
<i>Sphagnum</i>	<i>Sphagnum cuspidatum</i>	<i>Eriophorum angustifolium</i>
<i>Eriophorum</i>	<i>Eriophorum angustifolium</i>	<i>Polytrichum commune</i>
<i>Bare peat</i>	–	–
<i>Open water</i>	–	<i>Occasional green algae</i>

2.4 Greenhouse Gas Flux Measurements

2.4.1 Carbon Dioxide

CO₂ fluxes were measured from November 2008 to December 2009 at biweekly (summer months) to monthly (winter months) intervals using the static chamber method (Alm *et al.* 1997) generally between 8 a.m. and 6 p.m. Instantaneous NEE was measured over a range of PPFD ($\mu\text{mol m}^{-2} \text{s}^{-1}$) values using a transparent polycarbonate chamber (Figure 2.1, 60 x 60 x 33cm). For each measurement, the chamber was placed in a water-filled channel at the top of the collar and CO₂ concentration (ppmv) in the chamber headspace was measured at 15-second intervals over a period of 60–180 seconds using a portable CO₂ analyser (EGM-4) (PP Systems, UK). PPFD was measured by a quantum sensor (PAR-1, PP Systems) located at the top of the chamber. At the same time, air temperature within the chamber was recorded. Concurrent with the chamber measurements, soil temperatures (at 5 and 10cm depths) were recorded at each of the collars with a soil temperature probe (ELE International, UK) and WT position relative to the soil surface was manually measured with a water level probe (Eijkelkamp Agrisearch Equipment, The Netherlands).



Figure 2.1. Static chamber employed to measure net ecosystem exchange (NEE).

Following each NEE measurement, the chamber was vented for a short time by removing it from the collar. This was carried out in order to ensure equilibration of the gas concentration. The chamber was then replaced in the collar and covered with an opaque material in order to provide an estimate of ecosystem respiration (R_{ECO}).

CO₂ flux rates ($\text{mg m}^{-2} \text{h}^{-1}$) were calculated from the linear change in CO₂ concentration in the chamber

headspace over time with respect to the chamber volume and temperature. A flux was accepted if the coefficient of determination (r^2) was at least 0.90. An exception was made in cases where the flux was close to zero and where the r^2 is always low (Alm *et al.* 2007b). Positive fluxes indicated a net loss of CO₂ and negative values indicated a net uptake of CO₂. An estimate of gross photosynthesis (P_G) was calculated as the sum of NEE and R_{ECO} values (Alm *et al.* 1997).

2.4.2 Methane and Nitrous Oxide

CH₄ and N₂O fluxes were measured at monthly intervals using the static chamber method (Crill 1991), which consisted of a polycarbonate chamber (60 x 60 x 25cm) equipped with a battery-operated fan, which mixed the air within the chamber headspace. Four 50ml samples were withdrawn into 60ml polypropylene syringes from the chamber headspace at 5-minute intervals over a 20-minute period (Fig. 2.2). The measurement period was increased to 40 minutes during wintertime when low fluxes were expected (Laine *et al.* 2007b). During each measurement, air temperature inside the chamber, soil temperature (at 5 and 10cm depths) and WT outside the chamber were recorded. Gas samples were analysed for CH₄ and N₂O concentrations within 24 hours of collection with a gas chromatograph with an attached auto-sampler unit (Shimadzu GC-2014, LAL, Gottingen, Germany) using a flame ionisation detector (FID) and an electron capture detector (ECD). Detector temperatures were 200°C (FID) and 310°C (ECD) and the oven temperature was 70°C (Lofffeld *et al.* 1997). Nitrogen was used as the carrier gas (22 ml min⁻¹). CH₄ (1.8, 3.99 and 10ppm) and N₂O standards (0.30, 0.80 and 9.96ppm) from BOC Gases Ireland Ltd were used. Gas peaks were integrated using Peak Simple software



Figure 2.2. Static chamber employed to measure CH₄ and N₂O fluxes.

(SRI Inc. Silicon Valley, California, USA). Fluxes ($\text{mg m}^{-2} \text{h}^{-1}$) were calculated from the linear change in gas concentration as a function of time, chamber volume and temperature. A flux was accepted if the r^2 was at least 0.90. An exception was made in cases where the flux was close to zero and where the r^2 is always low (Alm *et al.* 2007b). Positive values indicated a loss of CH_4 and N_2O to the atmosphere and negative flux values indicated CH_4 and N_2O uptake.

2.5 Greenhouse Gas Flux Modelling Methods

2.5.1 Carbon Dioxide

2.5.1.1 Gross photosynthesis (P_G)

Gross photosynthesis (P_G) is strongly dependent on irradiation (PPFD) and is commonly described by the Michaelis-Menten function showing a hyperbolic response approaching an asymptotic maximum. The seasonal variation in the photosynthetic capacity of the vegetation is described by GAI and incorporated into the model in a manner similar to Wilson *et al.* (2007b) (Eqn 2.1, 2.2 and 2.3).

$$P_G = P_{max} \left(\frac{PPFD}{PPFD + k_{PPFD}} \right) * GAI * (\exp(-0.5 ((WTD-a)/b)^2)) \quad (\text{Eq. 2.1})$$

$$P_G = P_{max} \left(\frac{PPFD}{PPFD + k_{PPFD}} \right) * GAI \quad (\text{Eq. 2.2})$$

$$P_G = P_{max} \left(\frac{PPFD}{PPFD + k_{PPFD}} \right) * (1 - \exp(-a * GAI)) \quad (\text{Eq. 2.3})$$

Where:

P_G is gross photosynthesis, P_{max} is maximum photosynthesis, PPFD is photosynthetic photon flux density, k_{PPFD} is the PPFD value at which P_G reaches half its maximum, GAI is green area index, WTD is water table depth, and a and b are model parameters.

2.5.1.2 Ecosystem respiration (R_{ECO})

Respiration rates are strongly influenced by both temperature and the water table. A linear model was applied between log-transformed R_{ECO} and soil temperature at 5cm depth (T_{5cm}) and WTD (Eq. 2.4).

$$\ln R_{ECO} = a + (b * T_{5cm}) + (c * WTD) \quad (\text{Eq. 2.4})$$

For the bare peat microsite, a sigmoidal curve with WTD as the explaining variable was used (Eq. 2.5).

$$R_{ECO} = \frac{a}{(1 + \exp(-(WTD - a)/b))} \quad (\text{Eq. 2.5})$$

Where:

R_{ECO} is ecosystem respiration, T_{5cm} is temperature at 5cm depth in the peat, WTD is water table depth, and a , b and c are model parameters.

2.5.2 Methane (CH_4)

CH_4 fluxes were closely related to the soil temperature at 10cm depth (T_{10cm}) and to either WTD (Eq. 2.6) or GAI (Eq. 2.7):

$$\text{CH}_4 = (\exp(a * T_{10cm})) * (b + (c * WTD)) \quad (\text{Eq. 2.6})$$

$$\text{CH}_4 = (\exp(a * T_{10cm})) * (b + (c * GAI)) \quad (\text{Eq. 2.7})$$

Where:

T_{10cm} is temperature at 10cm depth in the peat, WTD is water table depth, GAI is the green area index, a , b and c are model parameters.

Gross photosynthesis (P_G), ecosystem respiration (R_{ECO}) and CH_4 were parameterised separately for each microsite (Table 3.1). Model coefficients were estimated either using the Levenberg-Marquardt multiple non-linear regression technique or multiple linear regression techniques (SPSS, Version 15.0 for Windows, SPSS Inc. Chicago, USA). One-third of the data was randomly removed from all data sets and used to test the models independently. Model evaluation was based on the following criteria: (i) statistically significant model parameters ($p < 0.05$), (ii) lowest possible standard error of the model parameters and (iii) highest possible coefficient of determination (adjusted r^2) (see Laine *et al.* 2009).

2.6 Reconstruction of Annual CO_2 -C Balance

The response functions estimated for P_G and R_{ECO} were used for the seasonal reconstruction of NEE. In combination with an hourly time series of (i) PPFD and T_{5cm} , recorded by the weather station and data loggers, (ii) modelled GAI and (iii) WT depths linearly interpolated from weekly measurements, P_G and R_{ECO} fluxes were reconstructed for each sample plot. NEE was then calculated on an hourly basis as follows: $\text{NEE} = P_G - R_{ECO}$ (Alm *et al.* 1997).

Negative NEE values indicated a net uptake of CO₂ from the atmosphere to the peatland and positive values indicated a net loss of CO₂ to the atmosphere. The annual CO₂-C balance (g C m⁻² yr⁻¹) was calculated for each sample plot by integrating the hourly NEE values over a 12-month period (1 January 2009 to 31 December 2009). An average value (± standard deviation) for each microsite was calculated from the annual CO₂-C balance of the sample plots within the microsite.

2.7 Reconstruction of Annual CH₄-C

The response functions estimated for CH₄ were used for the seasonal reconstruction of CH₄ fluxes. In combination with an hourly time series of (i) T_{10cm}, recorded by the data loggers, (ii) modelled GAI and (iii) WT depths linearly interpolated from weekly measurements, hourly CH₄ fluxes were reconstructed for each sample plot and integrated over a 12-month period (1 January 2009 to 31 December 2009). An average value (± standard deviation) for each microsite was calculated from the annual CH₄-C balance of the sample plots within the microsite.

2.8 Global Warming Potential Calculations

Global warming potential (GWP) (t CO₂-eq ha⁻¹ yr⁻¹) was calculated for each of the microsites in the study. A GWP (100-year horizon) of 1, 25 and 298 for CO₂, CH₄ and N₂O respectively was employed (IPCC 2007). CO₂, CH₄ and N₂O were converted into CO₂-eq values by multiplying annual flux rates with the respective GWP. Negative GWP values indicate that the microsite was a net GHG sink and had a net cooling effect on the climate. Positive values indicate that the microsite

was a net GHG source and had a net warming effect on the climate.

2.9 Economic Analyses

The impact of restoration on the value of C at Bellacorick was examined through a series of timeline scenarios that followed the change in land use from the cessation of peat extraction, through rewetting and on to the present day. Greenhouse gas flux values (t CO₂-eq ha⁻¹ yr⁻¹) from this study and from literature (Wilson *et al.* 2009) were used to estimate the annual GHG flux for each timeline. The price of C on the EU Emissions Trading Scheme (ETS) has fallen considerably since 2009 and currently (2012) trades at €15 t CO₂-eq (European Climate Exchange, 2010). For this exercise, a mid-range price of €20 t CO₂-eq. was used.

Timeline scenarios

T_{zero}: Peat extraction has ceased at Bellacorick and the peatland is characterised by the absence of vegetation. Drainage ditches are still functioning and, as a result, the WT level is on average 25cm below the peat surface (Wilson *et al.* 2009).

T₁: A year later, Bellacorick has been rewetted by the blocking of the drainage ditches. As a consequence of landscaping the peat surface, the WT level varies considerably throughout the peatland, on average 20cm above the peat surface in depressions to around 0.5cm below the peat surface on elevated areas. The peatland is covered by 50% bare peat and 50% open water.

T_{present}: Six years after rewetting, the surface of the peatland has been largely re-colonised by vegetation. Bare peat areas have declined to around 2% and open water to 5%. The main vegetation communities are *Juncus-Sphagnum* (30%), *Sphagnum* (30%), *Eriophorum* (30%) and others (3%).

3 Results

3.1 Environmental Variables

Photosynthetic photon flux density (PPFD) values exhibited strong diurnal and seasonal variation (Fig. 3.1). Daily PPFD values were generally highest in the period from midday to 2 p.m. and lowest at night (zero). Seasonally, PPFD increased steadily from January, peaked in mid-June ($\sim 2000 \mu\text{mol m}^{-2} \text{sec}^{-1}$) and declined towards December. During the period of the study, the mean annual air temperature was 10.5°C which is a deviation from the long-term average value by +9%. Annual rainfall was 1326mm (Met Éireann, Belmullet Station), that is, a deviation from the long-term average value by +16%.

For the duration of the study, the WT level varied significantly between microsites (Fig. 3.2). The highest WT were recorded in the open-water microsites ($\sim 25\text{cm}$ above the peat surface) and the lowest in the bare peat (15cm below the peat surface). At all microsites, the WT remained constant throughout the duration of the study, with the exception of a noticeable dip in WT levels in June in response to lower than average rainfall levels (Fig. 3.1).

A strong, unimodal seasonality in the GAI was observed within all vegetated microsites (Fig. 3.3). Green area index (GAI) values increased during the spring, reaching a maximum in June/July for the

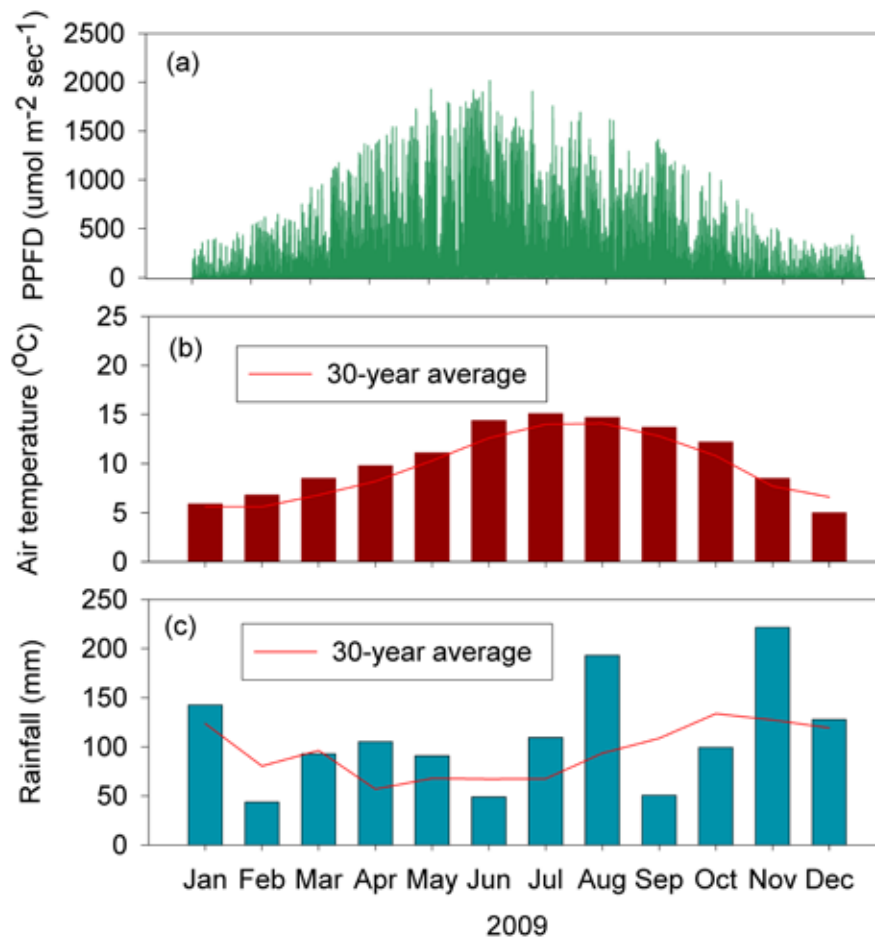

Figure 3.1. Climate data for Bellacorick, Co. Mayo in 2009. (a) Photosynthetic photon flux density (PPFD; $\mu\text{mol m}^{-2} \text{sec}^{-1}$), (b) monthly air temperature ($^\circ\text{C}$) and (c) monthly rainfall (mm) (Met Éireann – Belmullet Station).

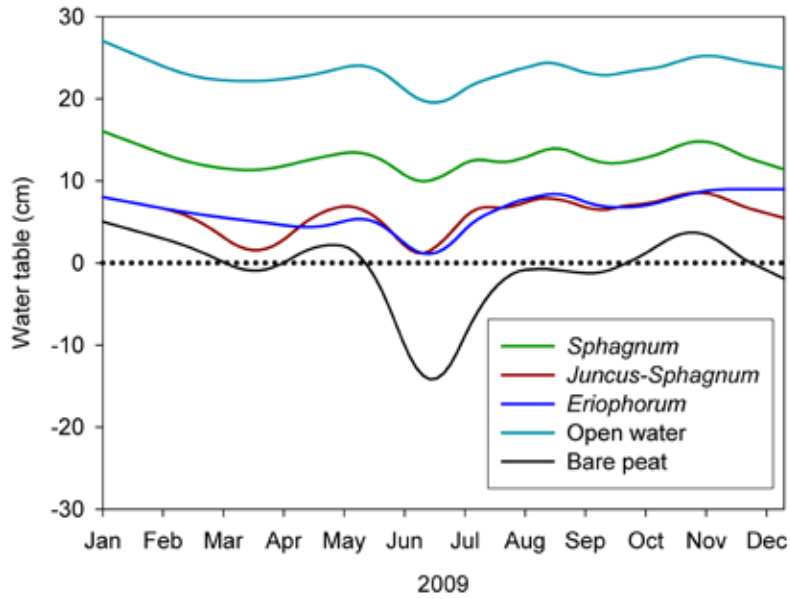

Figure 3.2. Water table (WT) data for the studied microsites in 2009. Dotted horizontal line indicates peat surface. Positive values indicate a WT position above the peat surface.

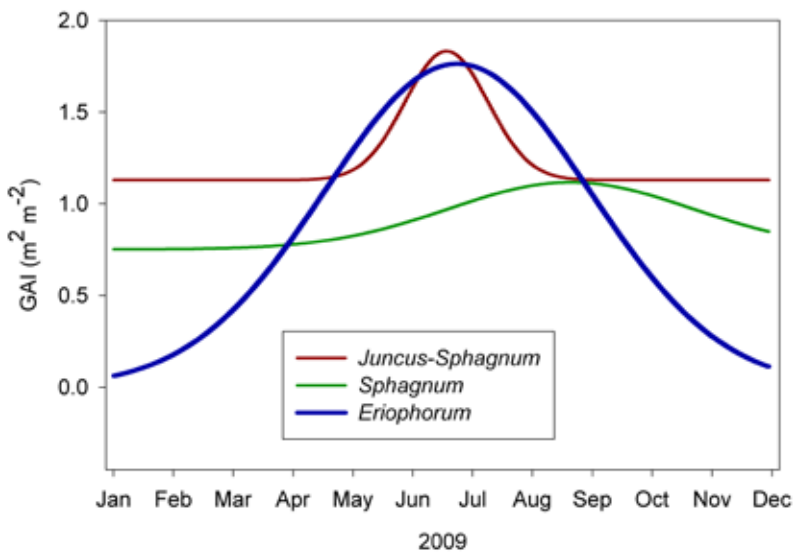

Figure 3.3. Modelled green area index (GAI, $m^2 m^{-2}$) for the vegetated microsites in 2009. For clarity purposes, only one sample plot for each microsite is shown.

Juncus-Sphagnum and *Eriophorum* microsites, and in September for the *Sphagnum* microsite. Thereafter they declined, although GAI values were still significant during the winter months (November–February) at the *Juncus-Sphagnum* and *Sphagnum* microsites as a consequence of the evergreen growth strategy of these communities.

3.2 Greenhouse Gas Flux Modelling

The strength of the relationship between CO_2 fluxes and the environmental variables varied between the microsites. A close relationship between gross photosynthesis (P_G) and PPFD was observed for all the microsites. The addition of GAI further improved the

Table 3.1. Estimated parameter values for gross photosynthesis (P_G), ecosystem respiration (R_{ECO}) and methane (CH_4) models for each microsite. Standard error in parentheses. Coefficient of determination (r^2) values and equation number are shown. P values for all parameters < 0.005.

	<i>Juncus-Sphagnum</i>	<i>Sphagnum</i>	<i>Eriophorum</i>	Bare peat
Model parameters				
P_G				
Pmax	1135 (124)	711 (123)	3709 (473)	-
k_{PPFD}	830 (169)	845 (286)	1048 (270)	-
a	-3.04 (3.24)	-	1.63 (0.36)	-
b	12.84 (3.56)	-	-	-
r^2	0.80	0.64	0.73	-
Equation No.	2.1	2.2	2.3	
R_{ECO}				
				161.1 (22.2)
a	3.4	2.89 (0.64)	3.41 (0.107)	
b	0.154	0.157 (0.024)	0.13 (0.01)	-4.18 (0.77)
c	-0.107	-0.069 (0.042)	-0.061 (0.004)	-11.688 (2.01)
r^2	0.74	0.59	0.58	0.91
Equation No.	2.4	2.4	4	2.5
CH_4				
a	0.248 (0.048)	0.21 (0.032)	0.026 (0.025)	
b	0.061 (0.041)	0.111 (0.065)	0.281 (0.093)	
c	0.005 (0.001)	0.004 (0.004)	0.349 (0.165)	
r^2	0.74	0.77	0.61	
Equation No.	2.6	2.6	2.7	

explanatory power of the models (data not shown). A clear relationship between WT and P_G has been noted in other studies (Tuittila *et al.* 2004) and the incorporation of WT (Eq. 2.1) improved the performance of the P_G model for the *Juncus-Sphagnum* microsite ($r^2=0.80$). However, no statistically significant relationship between P_G and WT was observed for the other microsites. Modelling of CO_2 exchange proved problematic with the open-water microsite, as no statistically significant relationship between CO_2 fluxes and environmental variables was observed. Instead, monthly mean values were calculated and integrated over the 12-month study period.

A strong relationship between R_{ECO} and T_{5cm} , WT was observed at all microsites ($r^2=0.58-0.74$), with the exception of the bare-peat microsite where WT was the sole explaining variable ($r^2=0.91$). CH_4 fluxes were strongly correlated ($r^2=0.61-0.77$) with the soil temperature at 10cm depth (T_{10cm}) and WT (Eq. 2.6)

or GAI (Eq. 2.7). No statistically significant relationship between CH_4 fluxes and environmental variables was observed in the open-water and bare-peat microsites. Instead, monthly mean values were calculated and integrated over the 12-month study period. Measured N_2O fluxes throughout the study period were negligible and below the detection level of the equipment (data not shown).

3.3 Annual CO_2 -C Balance

In 2009, the vegetated microsites sequestered on average $279\pm 246g CO_2-C m^{-2} yr^{-1}$. Average values for the individual microsites were $106\pm 3.66g CO_2-C m^{-2} yr^{-1}$ for *Sphagnum*, $143\pm 8.85g CO_2-C m^{-2} yr^{-1}$ for *Juncus-Sphagnum* and $577\pm 160.69g CO_2-C m^{-2} yr^{-1}$ for the *Eriophorum* microsite (Fig. 3.4). There was considerable spatial variation in NEE both within and between microsites, driven by differences in WT level and GAI. Very high NEE values were observed within

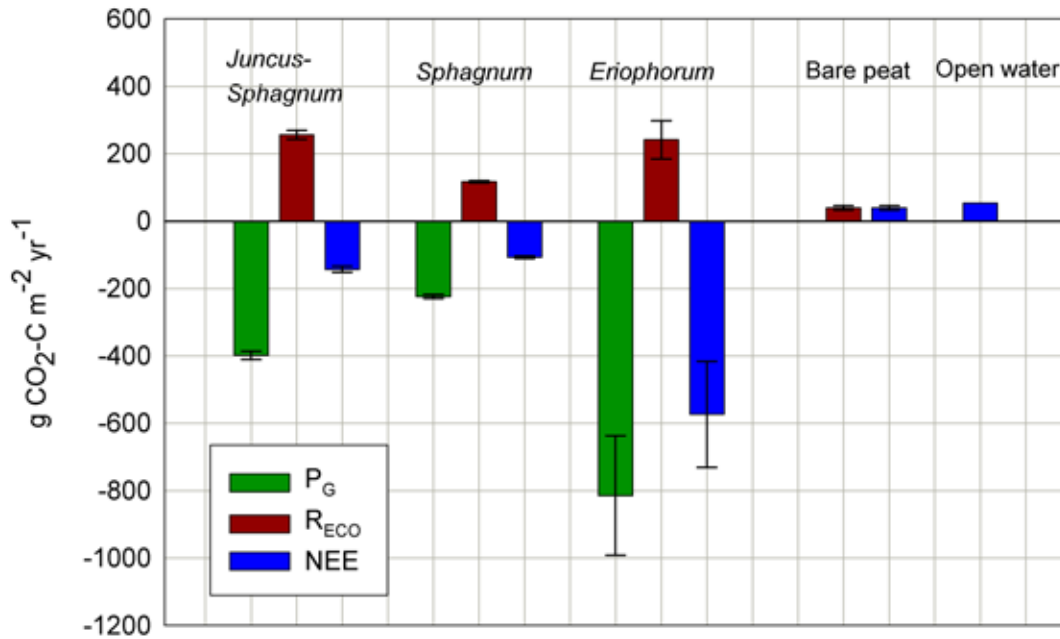

Figure 3.4. Average annual gross photosynthesis (P_G), annual ecosystem respiration (R_{ECO}) and net ecosystem exchange (NEE) (g CO₂-C m⁻² yr⁻¹) ± standard deviation for the microsites at Bellacorick, Co. Mayo for 2009. $NEE = P_G - R_{ECO}$. Negative NEE values indicate that the microsite was a net sink for CO₂-C and positive NEE values indicate that the microsite was a net source of CO₂-C from the peatland to the atmosphere in 2009.

the *Eriophorum* microsite, primarily as a result of high levels of P_G and moderate losses of CO₂-C from R_{ECO} . Lower NEE values were seen within the *Juncus-Sphagnum* and *Sphagnum* microsites, mainly because of lower P_G values (i.e. lower primary productivity). However, R_{ECO} values within those microsites were also very low as a consequence of high WT positions. In general, R_{ECO} values at all microsites were relatively low (Fig. 3.4). NEE for the open-water microsite was estimated to be 53g CO₂-C m⁻² yr⁻¹. However, this result should be treated with caution, as the values for the open-water microsite are monthly mean values with no ecological foundation and limited statistical confidence.

CO₂-C emissions from the bare-peat microsite (~40g CO₂-C m⁻² yr⁻¹) are similar to values reported for other rewetted cutaway peatlands (Bortoluzzi *et al.* 2006, Kivimäki *et al.* 2008) but are considerably lower than those reported for bare peat extraction areas (see Table 1.1), highlighting the importance of WT management in minimising CO₂ emissions. The maintenance of high WT levels throughout the year at the study site ensured that decomposition of the

residual peat remained low and that R_{ECO} was largely dominated by autotrophic respiratory losses.

3.4 Annual CH₄-C Balance

The vegetated microsites in this study released an average of 10.1±3.6g CH₄-C m⁻² yr⁻¹ to the atmosphere in 2009. Average values for the individual microsites were 0.11g CH₄-C m⁻² yr⁻¹ for the bare peat, 0.29g CH₄-C m⁻² yr⁻¹ for the open water, 5.38±1.43g CH₄-C m⁻² yr⁻¹ for *Eriophorum*, 11.83±0.27g CH₄-C m⁻² yr⁻¹ for *Juncus-Sphagnum* and 13.1±0.15g CH₄-C m⁻² yr⁻¹ for *Sphagnum* (Fig. 3.5). The persistently high WT levels throughout the year (in particular during the growing season) created optimal conditions for the CH₄ production. The highest CH₄ emissions in this study occurred within the vegetated microsites where the WT level remained highest (i.e. *Sphagnum*). The strong relationship between high WT levels and the availability of fresh organic matter (litter and root exudates) on the one hand and CH₄ emissions on the other has been observed in many studies (Bubier 1995, Saarnio *et al.* 1997, Ström *et al.* 2003, Saarnio *et al.* 2004, Wilson *et al.* 2009).

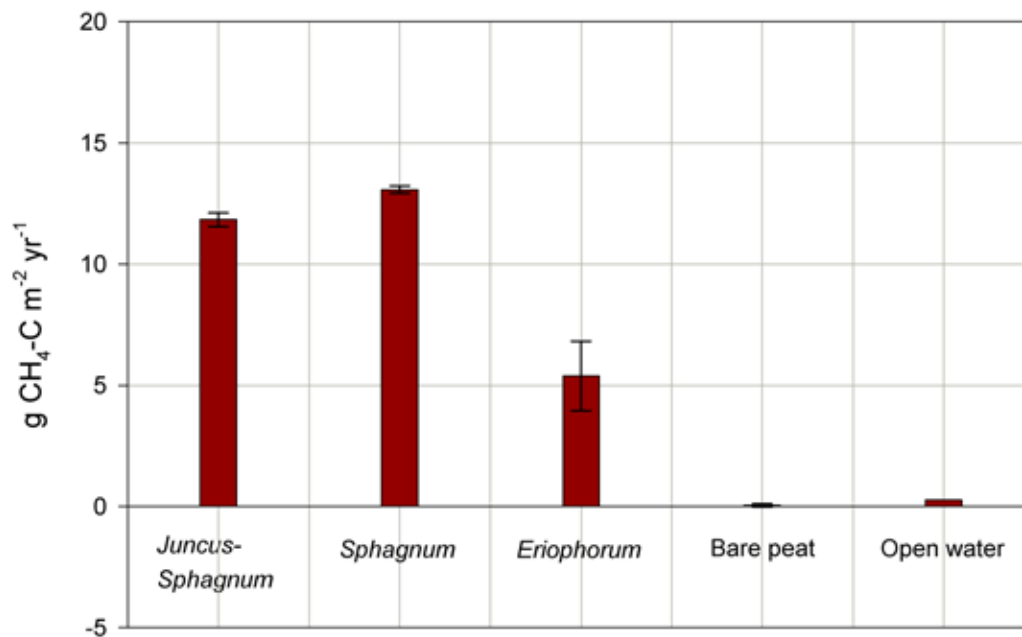

Figure 3.5. Average annual CH₄ fluxes (g CH₄-C m⁻² yr⁻¹) ± standard deviation for the microsites at Bellacorick, Co. Mayo in 2009. Positive values indicate a net emission of CH₄ from the peatland to the atmosphere.

3.5 Global Warming Potential for the Study Site

For the period of the study, the microsites had either a net warming impact (GHG source) or a net cooling impact (GHG sink) on the climate over a 100-year horizon (Table 3.2). The open-water microsite was the largest GHG source, releasing 2.04t CO₂-eq ha⁻¹ yr⁻¹ to the atmosphere. However, as stated above, very high uncertainties are to be associated with this value because of the limited statistical treatment of the data from the open-water microsite. Both the bare peat (1.45t CO₂-eq ha⁻¹ yr⁻¹) and *Sphagnum* (0.46t CO₂-eq ha⁻¹ yr⁻¹)

microsites were GHG sources for 2009. In the latter, CH₄ emissions were the dominant component of the GWP. The *Juncus-Sphagnum* (1.30t CO₂-eq ha⁻¹ yr⁻¹) and *Eriophorum* (19.33t CO₂-eq ha⁻¹ yr⁻¹) microsites were GHG sinks. In particular, *Eriophorum* had a strong cooling impact on the climate, driven by large CO₂ sequestration rates and moderate CH₄ emissions. Studies elsewhere have shown that GWP may not be the most appropriate measure for assessing the contribution of peatlands to the global climate, given that fluxes are rarely pulse events and vary considerably over time (Frolking *et al.* 2006, Frolking and Roulet 2007). Similarly, research has shown that the choice

Table 3.2. Global warming potential (GWP, t CO₂-eq ha⁻¹ yr⁻¹, 100 year horizon) for the microsites at Bellacorick, Co. Mayo in 2009. Standard deviation in parentheses. Negative values indicate that the microsite was a net greenhouse gas (GHG) sink and had a net cooling impact on the climate for the period of the study. Positive values indicate that the microsite was a net GHG source and had a net warming impact on the climate for the period of the study.

	CO ₂	CH ₄	N ₂ O	Total
Microsite	(t CO ₂ -eq ha ⁻¹ yr ⁻¹)	(t CO ₂ -eq ha ⁻¹ yr ⁻¹)	(t CO ₂ -eq ha ⁻¹ yr ⁻¹)	(t CO ₂ -eq ha ⁻¹ yr ⁻¹)
<i>Juncus-Sphagnum</i>	-5.23 (0.32)	+3.93 (0.09)	0	-1.30
<i>Sphagnum</i>	-3.88 (0.13)	+4.34 (0.05)	0	+0.46
<i>Eriophorum</i>	-21.12 (5.89)	+1.79 (0.48)	0	-19.33
Bare peat	+1.41 (0.22)	+0.037	0	+1.45
Open water	+1.94	+0.096	0	+2.04

of time horizon employed in the GWP calculation can influence the GHG sink/status of the peatland (Joosten and Clarke 2002, Drösler 2005, Höper *et al.* 2008, Drewer *et al.* 2010). For example, the use of the 500-year horizon in this study would have resulted in all the vegetated microsites producing a net cooling effect on the climate.

3.6 Economic Analyses

Considerable variation was found in the value of C between the three timeline scenarios. At T_{zero} , when peat extraction at Bellacorick has ceased, Wilson *et al.* (2009) estimated that around 11t CO₂-eq ha⁻¹ yr⁻¹ would be emitted to the atmosphere from bare peat areas where the WT level remains low. At a C price of €20 t CO₂-eq, this equates to a total loss of €220 ha⁻¹ for the T_{zero} scenario (Fig. 3.6). When the peatland is rewetted (T_1), emissions decreased significantly as a result of higher WT levels (values from the bare peat microsite in this study) and the cost of C emitted from the peatland decreased to around €35 ha⁻¹, resulting in an avoided loss of C of €186 ha⁻¹. In the time from rewetting until this study ($T_{present}$), recolonisation of the peatland by a range of vegetation communities,

combined with the maintenance of a high WT level led to a situation whereby the peatland is now a net GHG sink and the value of C sequestered for $T_{present}$ is around €118 ha⁻¹. This is added to the avoided loss of C of €220 ha⁻¹ to give a total of €318 ha⁻¹ for the year of this study ($T_{present}$).

Clearly, these values are subject to change in regard to the upward or downward movement in the traded price of C. However, the differences between the three scenarios are driven not by the traded price of C but by the magnitude of measured GHG fluxes. In the absence of data for the years between T_1 and $T_{present}$, it is impossible to estimate the point when the peatland switched from acting as a net GHG source to a net GHG sink, nor indeed to assess the magnitude of annual fluxes in that time period. Nevertheless, it is likely that the peatland would have continued along a development trajectory that would have resulted in continued C savings through avoided losses (Fig. 3.6, dotted line). This is estimated to have mitigated around 75.3t CO₂-eq ha⁻¹ (€1506 ha⁻¹) for the time period T_1 to $T_{present}$. Furthermore, by moving from T_{zero} to T_1 , the investment in rewetting is paid back by emissions reductions within two years.

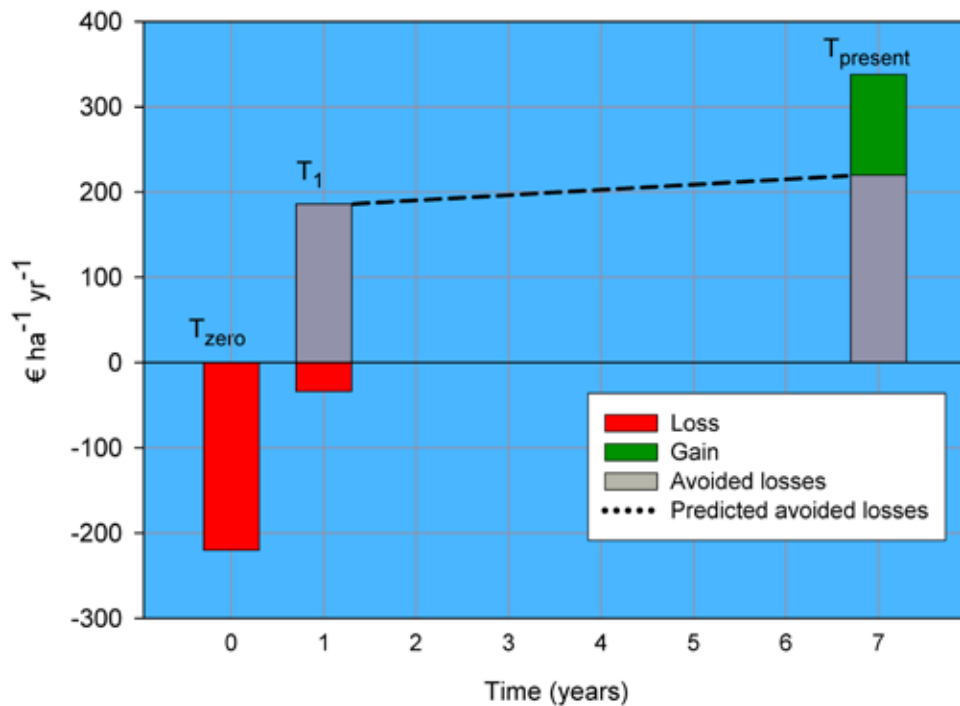

Figure 3.6. Value of C (€ ha⁻¹ yr⁻¹) for timeline scenarios, T_{zero} , T_1 and $T_{present}$. Dotted line indicates predicted avoided costs for the years between scenarios. A C price of €20t CO₂-eq is assumed. Greenhouse gas (GHG) values taken from literature and this study.

4 Discussion and Conclusions

Since the 1990s, the impact of restoration on C gas dynamics in industrial cutaway peatlands has received considerable attention in other countries but has been largely neglected in Ireland. Instead, studies in this country have focused on the C sequestration potential of alternative land-use options, such as afforestation, natural regeneration and amenity wetlands (Byrne *et al.* 2007a, Byrne *et al.* 2007b, Wilson *et al.* 2007b, Wilson *et al.* 2009). As such, this study represents the first investigation of the C sequestration potential of a restored industrial cutaway peatland in Ireland.

The results presented in this report suggest that the rewetting actions and subsequent re-colonisation of the highly degraded peatland at Bellacorick have been successful in creating suitable conditions for C sequestration. There are a number of reasons why the CO₂-C sink values for 2009 are at the upper range of reported values for rewetted peatlands (Tuittila *et al.* 1999, Yli-Petäys *et al.* 2007, Kivimäki *et al.* 2008). Firstly, given the successional stage of the peatland, biomass and litter are still increasing rapidly but over time will reach a steady-state equilibrium in terms of the rate of C sequestration. After that, the accumulation of organic matter (and the C therein) in a new peat layer is typically much slower (Lucchese *et al.* 2010). Secondly, under a mild temperate climate, the growing season is considerably longer than in boreal climates, providing an extended timeframe for C uptake (Wilson *et al.* 2007a). Combined with the wide coverage of evergreen moss species, such as *Sphagnum cuspidatum*, at the study site, photosynthetic activity and hence C uptake may take place even during the winter months (Fig. 3.3). Thirdly, the relatively low ecosystem respiration (R_{ECO}) values observed during the study further increase the margin between net C losses and net C gains. Research has shown a correlation between the nutrient status and the rate of decomposition of the peat (Couwenberg *et al.* 2008, Bayley *et al.* 2009). The high C:N ratio recorded at the site indicates that the residual peat at Bellacorick is nutrient poor and may result in lower microbial decomposition rates, and therefore, lower CO₂ production (Francez *et al.* 2000).

The moderate-high CH₄-C emissions reported here indicate that, in terms of C gas functioning, the peatland is now more reminiscent of a fen (historical precursor to a bog) than a bog ecosystem (Nykänen *et al.* 1998, Huttunen *et al.* 2003, Rinne *et al.* 2007, Drewer *et al.* 2010). Aerenchymatic plant species have been associated with high CH₄ emissions (Bubier 1995, Frenzel and Karofeld 2000, Riutta *et al.* 2007a). However, in this study, the highest CH₄ emissions occurred within the *Sphagnum*-dominated microsite, where *Eriophorum angustifolium* (an aerenchymatic species) was a minor component than in microsites dominated by aerenchymatic species (*Juncus-Sphagnum* and *Eriophorum*). Other studies have reported similar findings (e.g. Roura-Carol and Freeman 1999, Dinsmore *et al.* 2009a, Dinsmore *et al.* 2009b), linking increased oxidation of the rhizosphere by aerenchymatic plants to reduced CH₄ emissions (Fritz *et al.* 2011).

Fluvial C fluxes were not quantified in this study. Work by Waddington *et al.* (2008) at a restored peatland in Canada estimated the annual export of dissolved organic carbon (DOC) at between 3.4 and 4.8g C m⁻², with higher exports occurring in wetter years. Furthermore, they estimated that DOC losses from the restored site were significantly lower than losses from an adjacent cutover peatland.

Restoration at Bellacorick has not succeeded in returning the peatland to the state that existed immediately prior to peat extraction. At Bellacorick, the vegetation communities are not typical of those found in Atlantic blanket bogs, which are dominated by plant species such as *Schoenus nigricans* and *Molinea caerulea* (Farrell and Doyle 2003, Sottocornola *et al.* 2008). Similarly, blanket bogs have been shown to be modest sinks for CO₂-C (Koehler *et al.* 2010, Sottocornola and Kiely 2010) and low CH₄-C sources (Laine *et al.* 2007b, Koehler *et al.* 2010). In contrast, C gas fluxes at Bellacorick for 2009 were characterised by large sinks/sources. Notwithstanding this, restoration has instead started a new process, along a new developmental trajectory (Vasander *et al.* 2003). At this point in time,

it is difficult to determine the direction or speed that this new trajectory might follow. Given that so many of the environmental conditions that were present when the original peatland developed (e.g. climate, vegetation, hydrology, etc.) are unlikely to be present today (Charman 2002, Holden 2005), a number of developmental trajectories, with major implications for C sequestration, may develop over time (Holden 2005).

In the absence of active restoration measures, such as drain blocking and re-colonisation, there is a high probability that the cutaway peatland that existed at T_{zero} in the current research timeline scenarios would continue to be a strong net CO_2 source in the short and medium term as the peat is oxidised (Waddington *et al.* 2001, Waddington *et al.* 2002, Wilson *et al.* 2007b, Wilson *et al.* 2009). Studies have demonstrated that this type of ecosystem has a strong warming impact on the climate (Wilson *et al.* 2009) and the potential value of C emitted ($\text{€ ha}^{-1} \text{ yr}^{-1}$) may be high (Fig. 3.6). This may decrease slightly over time as the more easily decomposable fractions of the peat are oxidised in the early years. With minimal human intervention, natural succession will take place and the cutaway will be re-colonised by a range of dryland plant species. In Ireland, this has generally resulted in the establishment of birch/willow scrub on drained industrial cutaways (Renou *et al.* 2006). However, studies have shown that

these ecosystems may be net C gas sources, primarily as a consequence of high soil CO_2 emissions and low primary productivity (von Arnold *et al.* 2005, Byrne *et al.* 2007b).

At Bellacorick, the direction of the new trajectory will be governed to a large extent by management and climatic factors. Climate modelling exercises have predicted that precipitation distribution and frequency will change in Ireland over the coming decades (Sweeney *et al.* 2002, Sweeney *et al.* 2008). During the period of the study, rainfall was 16% higher than the long-term average. In fact, 2009 was the eighth wettest year since 1957 (Fig. 4.1) and this undoubtedly contributed to the high WTs observed at the study site. If annual precipitation levels increase over the next decades then it is possible that the peatland at Bellacorick may continue along a developmental trajectory towards a bog ecosystem. Similarly, if rainfall frequency and distribution are below the long-term average, it is likely that the strength of the C sink function may be reduced, particularly as the amount of C stored in the biomass will begin to reach a steady-state C sequestration saturation point (Anderson *et al.* 2008). Prolonged periods of drought may result in the peatland undergoing a second wave of re-colonisation, this time by dryland plant species, which might lead to further drying of the peatland. The impact of future climate

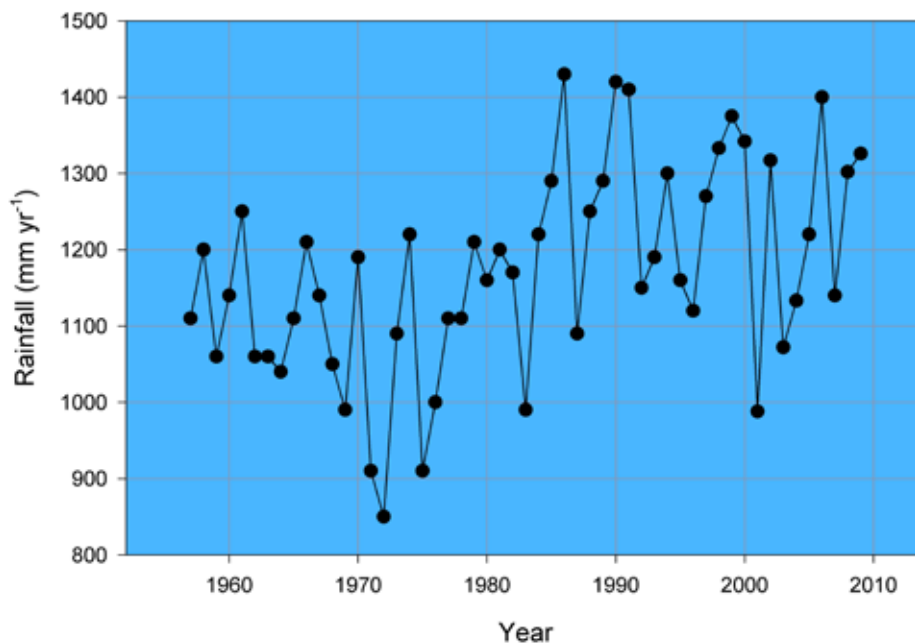

Figure 4.1. Rainfall (mm yr^{-1}) at Belmullet Meteorological Station, Co. Mayo 1957–2009. Data from Central Statistics Office (CSO).

change on peatlands in general is highly uncertain as a consequence of response variations both between and within individual peatlands (Moore *et al.* 1998, Welker *et al.* 2004) and potential positive and negative feedbacks driven by changes in climate (Bridgham *et al.* 1995). Work by Jones *et al.* (2006) has predicted that around 40% of Irish peatlands could disappear over the coming decades as a consequence of climate change. Given that degraded peatlands are likely to be more vulnerable to external changes than natural peatlands, well-informed management decisions will be critical in maintaining optimal conditions for C sequestration. These may involve the removal of colonising trees to prevent increased rates of evapotranspiration and the subsequent drying-out of the peatland, as well as the maintenance of drainage dams and bunds to ensure that the WT remains high throughout the peatland (Schumann and Joosten 2008).

As noted above, the potential for restored peatlands as a climate-mitigation option has been discussed widely in recent years (Couwenberg *et al.* 2008, Parish *et al.* 2008, Joosten and Couwenberg 2009), particularly at the UNFCCC Conference of the Parties (COP) meetings. The voluntary and mandatory C trading schemes that are currently in operation imply that C, both stored and annually sequestered, could have an economic and tradable value if they can be reported and verified accurately (Galatowitsch 2009, Joosten

and Couwenberg 2009, Worrall *et al.* 2009b). Given the considerable C savings achieved in the years since rewetting at Bellacorick, the suitability of restored industrial peatlands as C offset projects is good provided (i) the restoration process is as successful on degraded peatlands elsewhere and (ii) the price of C traded on the markets is attractive.

In conclusion, restoration of degraded peatlands offers a number of important benefits in terms of C gas exchange. Firstly, the re-establishment and, more importantly, the maintenance of hydrological conditions characteristic of natural peatlands minimises CO₂ emissions from the peat and leads to a potential C saving or avoided loss (T₁ scenario, [Figure 3.6](#)). Furthermore, the re-establishment of the C sequestration capability of the peatland through re-colonisation by appropriate vegetation communities may further reduce C losses from the peatland and/ or enhance C storage (T_{present} scenario, [Fig. 3.6](#)). As this study represents a single 12-month period, further investigation is required as uncertainties are obviously high and care should be taken in interpreting the values reported. Inter-annual variations in C gas exchange are a strong feature of peatlands in general, driven mainly by variations in climatic inputs. Long-term monitoring is essential to more accurately assess the potential for this peatland, in particular, and restored peatlands, in general, to sequester C.

5 Observations and Recommendations

Observation 1: Drained industrial cutaway peatlands are a significant net GHG source. Practical rehabilitation measures, such as a simple rewetting programme at Bellacorick, resulted in a sharp decrease in CO₂ emissions and minimal CH₄ emissions from bare-peat areas. Furthermore, the initial rewetting is likely to have reduced the GWP of the site by 87% (i.e. the peatland had a less warming impact on the climate).

Recommendation: Management plans for the cutaway should be in place in advance of the cessation of peat extraction. For cutaways that have the potential to be restored/rewetted, drainage ditches should be blocked as soon as possible following the cessation of peat extraction at an individual peatland to minimise potential emissions of CO₂ from the peat and, thereby, lower the GWP.

Observation 2: The rewetted cutaway peatland at Bellacorick, which developed typical peat-forming vegetation, was a strong CO₂-C sink and CH₄-C source for 2009. N₂O-N fluxes were zero. The GWP of vegetated areas varied from net cooling to net warming over a 100-year horizon.

Recommendation: Given the very dynamic nature of vegetation change at the peatland, and the strong inter-annual variation in GHG fluxes of peatlands in general, long-term monitoring of GHG fluxes is essential to accurately quantify the changes that are likely to take place at Bellacorick in the future.

Observation 3: The results from this study have shown that the peatland has regained some of the ecological functioning characteristic of an earlier stage in its development trajectory. The restoration of the C sink function has occurred over a short time frame following initial rewetting. However, it is not certain at this point in time as to what ecological direction the peatland might take in the future.

Recommendation: Management decisions can influence the future direction to some extent. Maintenance of the site (blocking drains, removal of trees, etc.) is essential to ensure that WT levels

remain appropriately high at the site, particularly throughout the main growing season (April to October). Absence of management input may lead to a progressive change in the site towards a dryland species cover.

Observation 4: Rewetting of drained peatlands is likely to be addressed in future climate talks and the C credits accrued may be seen as a possible climate mitigation option. Currently, there are no good practice guidelines available for the development of peat-rewetting methodologies under either the mandatory or voluntary markets. However, the IPCC has signalled that it intends to address this area shortly, and the VCS programme has adopted a Peatland Rewetting and Conservation (PRC) module in its AFOLU standard which allows voluntary C trading schemes.

Recommendation: The support for credits to be allowed for C storage through peatland conservation or restoration should be supported by Ireland in the negotiation of the Kyoto Protocol, and by active engagement in the development of good practice guidelines for peatland rewetting. In this regard, long-term monitoring of GHG fluxes is essential in order to accurately quantify, report and verify.

Observation 5: Rewetting of drained peatlands can lead to restoration of functional peatland aspects, such as the return of typical peatland species, which in turn may lead to the restoration of peat-formation and the C-sink function. This is not possible in all degraded peatland sites, but is a practical and a relatively simple measure in some sites.

Recommendation: The restoration potential of individual degraded peatlands and, in particular, the industrial cutaway bogs, needs to be assessed at the field-site level to determine the most cost-effective approach, the maximum areas of benefit and appropriate measures to employ.

References

- Alm J., Talanov A., Saarnio S., Silvola J., Ikkonen E., Aaltonen H., Nykänen H. & Martikainen P. J. 1997. Reconstruction of the carbon balance for microsites in a boreal oligotrophic pine fen, Finland. *Oecologia* 110: 423–31.
- Alm J., Schulman L., Walden J., Nykänen H., Martikainen P. J. & Silvola J. 1999. Carbon balance of a boreal bog during a year with an exceptionally dry summer. *Ecology* 80(1): 161–74.
- Alm J., Shurpali N. J., Minkkinen K., Aro L., Hytönen J., Laurila T., Lohila A., Maljanen M., Martikainen P. J., Mäkiranta P., Penttilä T., Saarnio S., Silvan N., Tuittila E.-S. & Laine J. 2007a. Emission factors and their uncertainty for the exchange of CO₂, CH₄ and N₂O in Finnish managed peatlands. *Boreal Environment Research* 12: 191–209.
- Alm J., Shurpali N. J., Tuittila E.-S., Laurila T., Maljanen M., Saarnio S. & Minkkinen K. 2007b. Methods for determining emission factors for the use of peat and peatlands – flux measurements and modelling. *Boreal Environment Research* 12: 85–100.
- Anderson J., Beduhn R., Current D., Espeleta J., Fissore C., Gangeness B., Harting J., Hobbie S. E., Nater E. & Reich P. 2008. *The potential for terrestrial carbon sequestration in Minnesota*. A Report to the Department of Natural Resources from the Minnesota Terrestrial Carbon Sequestration Initiative. University of Minnesota, St Paul, Mn.
- Augustin J., Merbach W. & Rogasik J. 1998. Factors influencing nitrous oxide and methane emissions from minerotrophic fens in northeast Germany. *Biology and Fertility of Soils* 28(1): 1–4.
- Bäckstrand K., Crill P. M., Jackowicz-Korczyński M., Mastepanov M., Christensen T. R. & Bastviken D. 2010. Annual carbon gas budget for a subarctic peatland, Northern Sweden. *Biogeosciences* 7: 95–108.
- Bayley S. E., Thormann M. N. & Szumigalski A. R. 2009. Nitrogen mineralization and decomposition in western boreal bog and fen peat. *Ecoscience* 12(4): 455–65.
- Belyea L. R. & Clymo R. S. 2001. Feedback control of the rate of peat formation. *Proc. R. Soc. Lond. B* 268: 1315–21.
- Belyea L. R. & Malmer N. 2004. Carbon sequestration in peatland: patterns and mechanisms of response to climate change. *Global Change Biology* 10: 1043–52.
- Bord na Móna. 2003. *Cutaway bog rehabilitation*. Bord na Móna.
- Bortoluzzi E., Epron D., Siegenthaler A., Gilbert D. & Buttler A. 2006. Carbon balance of a European mountain bog at contrasting stages of regeneration. *New Phytologist* 172: 708–18.
- Bridgman S. D., Johnston C. A., Pastor J. & Updegraff K. 1995. Potential feedbacks of Northern wetlands on climate change. *Bioscience* 45(4): 262–74.
- Broekhoff D. & Zyla K. 2008. *Outside the Cap: Opportunities and limitations of greenhouse gas offsets*. World Resources Institute Climate and Energy Policy Series. December 2008.
- Bubier J. L., Moore T. R. & Roulet N. T. 1993. Methane emissions from wetlands in the mid-boreal region of northern Ontario, Canada. *Ecology* 74(8): 2240–54.
- Bubier J. L. 1995. The relationship of vegetation to methane emission and hydrochemical gradients in northern peatlands. *Journal of Ecology* 83: 403–20.
- Bubier J. L., Moore T., Savage K. & Crill P. 2005. A comparison of methane flux in a boreal landscape between a dry and a wet year. *Global Biogeochemical Cycles* 19(GB1023): doi:10.1029/2004GB002351.
- Bullock C., Kretsch C. & Candon E. 2008a. *The Economic and Social Aspects of Biodiversity. Benefits and costs of biodiversity in Ireland*. Report commissioned by the Biodiversity Unit of the Department of the Environment, Heritage and Local Government.
- Bullock C., Renou-Wilson F. & Convery F. 2008b. Policy and the changing value of peatlands. In: Feehan J. (ed.), *13th International Peat Congress, Tullamore, Ireland*, International Peat Society, pp. 671–3.
- Byrne K. A., Cabral R. & Farrell E. P. 2007a. Commercial afforestation. In: Wilson D. & Farrell E. P. (eds.), *CARBAL. Carbon gas balances in industrial cutaway peatlands in Ireland*. University College Dublin, pp. 12–14.
- Byrne K. A., Cabral R., Pöllänen M. & Farrell E. P. 2007b. Natural regeneration. In: Wilson D. & Farrell E. P. (eds.), *CARBAL. Carbon gas balances in industrial cutaway peatlands in Ireland*. University College Dublin, pp. 15–17.
- Campbell D. R., Lavoie C. & Rochefort L. 2002. Wind erosion and surface stability in abandoned milled peatlands. *Canadian Journal of Soil Science* 82: 85–95.
- Campbell D. R., Rochefort L. & Lavoie C. 2003. Determining the immigration potential of plants colonising disturbed environments: the case of milled peatlands in Quebec. *Journal of Applied Ecology* 40: 78–91.

- Campeau S., Rochefort L. & Price J. S. 2004. On the use of shallow basins to restore cutover peatlands: Plant establishment. *Restoration Ecology* 12(4): 471–82.
- Cao M., Gregson K. & Marshall S. 1998. Global methane emission from wetlands and its sensitivity to climate change. *Atmospheric Environment* 32(19): 3293–9.
- Charman D. 2002. *Peatlands and Environmental Change*. John Wiley and Sons, Chichester UK.
- Cleary J., Roulet N. T. & Moore T. R. 2005. Greenhouse gas emissions from Canadian peat extraction, 1990–2000: a life cycle analysis. *Ambio* 34(6): 456–61.
- Connolly J. & Holden N. M. 2009. Mapping peat soils in Ireland: updating the derived Irish peat map. *Irish Geography* 42(3): 343–52.
- Cooper D. J. & MacDonald L. H. 2000. Restoring the vegetation of mined peatlands in the southern Rocky Mountains of Colorado, USA. *Restoration Ecology* 8(2): 103–11.
- Couwenberg J. 2009. *Methane emissions from peat soils (organic soils, histosols). Facts, MRV-ability, emission factors*. Wetlands International, [www.wetlands.org / WatchRead/Currentpublications/tabid/56/mod/1570/articleType/ArticleView/articleId/2359/Default.aspx](http://www.wetlands.org/WatchRead/Currentpublications/tabid/56/mod/1570/articleType/ArticleView/articleId/2359/Default.aspx).
- Couwenberg J., Augustin J., Michaelis D. & Joosten H. 2008. *Emission reductions from rewetting of peatlands. Towards a field guide for the assessment of greenhouse gas emissions from Central European peatlands*. University of Greifswald, Germany.
- Couwenberg J., Thiele A., Tanneberger F., Augustin J., Bärtsch S., Dubovik D., Liashchynskaya N., Michaelis D., Minke M., Skuratovich A. & Joosten H. 2011. Assessing greenhouse gas emissions from peatlands using vegetation as a proxy. *Hydrobiologia*: DOI:10.1007/s10750-011-0729-x.
- Crill P. M. 1991. Seasonal patterns of methane uptake and carbon dioxide release by a temperate woodland soil. *Global Biogeochemical Cycles* 5(4): 319–34.
- Curran P. L. & MacNaeidhe F. S. 1986. Weed invasion of milled-over bog. *Weed Research* 26: 45–50.
- Danone Fund for Nature. 2010. *Achieving Carbon Offsets through Mangroves and Other Wetlands. November 2009 Expert Workshop Meeting report*. Danone Group/IUCN/Ramsar Convention Secretariat, Gland, Switzerland.
- Delaney M. 2008. Bringing the bogs back to LIFE. In: Farrell C. A. & Feehan J. (eds.), *13th International Peat Congress: After Wise-Use: The Future of Peatlands, Tullamore, Co. Offaly, Ireland*, IPS, pp. 678–80.
- Dinsmore K. J., Skiba U. M., Billett M. F. & Rees R. M. 2009a. Effect of water table on greenhouse gas emissions from peatland mesocosms. *Plant and Soil* 318: 229–42.
- Dinsmore K. J., Skiba U. M., Billett M. F., Rees R. M. & Drewer J. 2009b. Spatial and temporal variability in CH₄ and N₂O fluxes from a Scottish ombrotrophic peatland: Implications for modelling and up-scaling. *Soil Biology and Biochemistry* 41: 1315–23.
- Dinsmore K. J., Billett M. F., Skiba U. M., Rees R. M., Drewer J. & Helfter C. 2010. Role of the aquatic pathway in the carbon and greenhouse gas budgets of a peatland catchment. *Global Change Biology* 16: 2750–62.
- Dise N. B. 2009. Peatland response to global change. *Science* 326(5954): 810–11.
- Douglas C., Valverde F. F. & Ryan J. 2008. Peatland habitat conservation in Ireland. In: Farrell C. A. & Feehan J. (eds.), *13th International Peat Congress: After Wise-Use: The Future of Peatlands, Tullamore, Co. Offaly, Ireland*, IPS, pp. 681–5.
- Drewer J., Lohila A., Aurela M., Laurila T., Minkinen K., Penttilä T., Dinsmore K. J., McKenzie R. M., Helfter C., Flechard C., Sutton M. A. & Skiba U. M. 2010. Comparison of greenhouse gas fluxes and nitrogen budgets from an ombrotrophic bog in Scotland and a minerotrophic sedge fen in Finland. *European Journal of Soil Science*: 10.1111/j.1365-2389.2010.01267.x
- Drösler M. 2005. Trace gas exchange and climatic relevance of bog ecosystems, southern Germany. Ph.D thesis, Universität München, Department für Ökologie Universität München, Germany, pp 182
- Egan T. 1998. A pilot project for the utilisation of cutaway boglands in West Offaly. In: O’Leary G. & Gormley F. (eds.), *Towards a Conservation Strategy for the Bogs of Ireland*. Irish Peatlands Conservation Council, Dublin, pp. 119–26.
- European Climate Exchange, Date accessed 28.8.2010, <http://www.ecx.eu>
- Farrell C. A. 2001. An ecological study of intact and industrial cutaway Atlantic blanket bog at Bellacorick, north-west Mayo. University College Dublin, Dublin.
- Farrell C. A. & Doyle G. J. 2003. Rehabilitation of industrial cutaway Atlantic blanket bog in County Mayo, north-west Ireland. *Wetlands Ecology and Management* 11: 21–35.
- Farrell C. A. 2008. The biodiversity value and future management of degraded peatland habitats in Ireland. In: Farrell C. A., Feehan, J. (ed.), *13th International Peat Congress: After Wise-Use: The Future of Peatlands. IPS, Tullamore, Co. Offaly, Ireland* pp. 686–9.
- Ferland C. & Rochefort L. 1997. Restoration techniques for *Sphagnum*-dominated peatlands. *Canadian Journal of Botany* 75: 1110–18.
- Foss P., O’Connell C. & Crushell P. H. 2001. *Bogs and Fens of Ireland. Conservation Plan 2005*. Irish Peatland Conservation Council, Dublin, Ireland.

- Francez A.-J., Gogo S. & Josselin N. 2000. Distribution of potential CO₂ and CH₄ productions, denitrification and microbial biomass C and N in the profile of a restored peatland in Brittany (France). *European Journal of Soil Biology* 36(3): 161–8.
- Freeman C., Evans C. D. & Monteith D. T. 2001. Export of organic carbon from peat soils. *Nature* 412: 785.
- Frenzel P. & Karofeld E. 2000. CH₄ emission from a hollow-ridge complex in a raised bog: The role of CH₄ production and oxidation. *Biogeochemistry* 51: 91–112.
- Fritz C., Pancotto V. A., Elzenga J. T. M., Visser E. J. W., Grootjans A. P., Pol A., Iturraspe R., Roelofs J. G. M. & Smolders A. J. P. 2011. Zero methane emission bogs: extreme rhizosphere oxygenation by cushion plants in Patagonia. *New Phytologist* 190(2): 398–408.
- Frolking S., Roulet N. T. & Fuglestedt J. 2006. How northern peatlands influence the Earth's radiative budget: Sustained methane emission versus sustained carbon sequestration. *Journal of Geophysical Research* 111: G01008, doi:10.1029/2005JG000091.
- Frolking S. & Roulet N. T. 2007. Holocene radiative forcing impact of northern peatland carbon accumulation and methane emissions. *Global Change Biology* 13: 1079–1088, doi:10.1111/j.1365-2486.2007.01339x.
- Galatowitsch S. M. 2009. Carbon Offsets as Ecological Restorations. *Restoration Ecology* 17(5): 563–70.
- Glatzel S., Forbrich I., Krüger C., Lemke S. & Gerold G. 2008. Small scale controls of greenhouse gas release under elevated N deposition rates in a restoring peat bog in NW Germany. *Biogeosciences* 5: 925–35.
- Goldberg S. D., Knorr K.-H., Blodau C., Lischeid G. & Gebauer G. 2010. Impact of altering the water table height of an acidic fen on N₂O and NO fluxes and soil concentrations. *Global Change Biology* 16: 220–33, doi:10.1111/J.1365-2486.2009.02015.x.
- Gorham E. 1991. Northern peatlands: role in the carbon cycle and probable responses to climatic warming. *Ecological Applications* 1(2): 182–95.
- Groeneveld E. V. G., Massé A. & Rochefort L. 2007. *Polytrichum strictum* as a nurse-plant in peatland restoration. *Restoration Ecology* 15(4): 709–19.
- Hamilton K., Sjardin M., Peters-Stanley M. & Marcello T. 2010. *Building bridges: State of the voluntary carbon markets 2010. A report by Ecosystem Marketplace and Bloomberg New Energy Finance*. New York and Washington, USA.
- Hansen L. T. 2009. The viability of creating wetlands for the sale of carbon offsets. *Journal of Agricultural and Resource Economics* 34(2): 350–65.
- Holden J. 2005. Peatland hydrology and carbon release: why small-scale process matters. *Philos. Trans. R. Soc. A* 363: 2891–13, doi:10.1098/rsta.2005.1671.
- Holmgren K., Kirkinen J. & Savolainen I. 2006. *The climate impact of energy peat utilisation - comparison and sensitivity analysis of Finnish and Swedish results*. IVL Swedish Environmental Research Institute.
- Höper H., Augustin J., Cagampan J., Droesler M., Lundin L., Moors E., Vasander H., Waddington M. & Wilson D. 2008. Restoration of peatlands and greenhouse gas balances. In: Strack M. (ed.), *Peatlands and climate change*. International Peat Society, Jyväskylä, Finland, pp. 182–210.
- Huopainen M., Tuittila E.-V., Laine J. & Vasander H. 1998. Seed and spore bank in a cut-away peatland twenty years after abandonment. *International Peat Journal* 8: 42–51.
- Huttunen J. T., Nykänen H., Turunen J. & Martikainen P. J. 2003. Methane emissions from natural peatlands in the northern boreal zone in Finland, Fennoscandia. *Atmospheric Environment* 37: 147–51.
- Intergovernmental Panel on Climate Change (IPCC). 2006. *IPCC Guidelines for National Greenhouse Gas Inventories. Prepared by the National Greenhouse Gas Inventories programme*. Institute for Global Environmental Strategies (IGES), Japan.
- IPCC. 2007. *Climate Change 2007: The Physical Science Basis. Contribution of Working Group I to the Fourth Assessment Report of the Intergovernmental Panel on Climate Change (Solomon, S., D. Qin, M. Manning, Z. Chen, M. Marquis, K. B. Ayerly, M. Tignor and H. L. Miller (eds.))*. Cambridge University Press Cambridge, U.K and New York, USA.
- Jaenicke J., Wösten H., Budiman A. & Siegert F. 2010. Planning hydrological restoration of peatlands in Indonesia to mitigate carbon dioxide emissions. *Mitig Adapt Strateg Glob Change* 15: 223–39, doi:10.1007/s11027-010-9214-5.
- Jager D. F., Wilmking M. & Kukkonen J. V. K. 2009. The influence of summer seasonal extremes on dissolved organic carbon export from a boreal peatland catchment: Evidence from one dry and one wet growing season. *Science of the Total Environment* 407: 1373–82.
- Jenkins W. A., Murray B. C., Kramer R. A. & Faulkner S. P. 2010. Valuing ecosystem services from wetlands restoration in the Mississippi Alluvial Valley. *Ecological Economics* 69: 1051–61.
- Joabsson A., Røjle Christensen T. & Wallen B. 1999. Vascular plant controls on methane emissions from northern peatforming wetlands. *Trends in Ecology and Evolution* 14(10): 385–8.
- Jones M. B., Donnelly A. & Albanito F. 2006. Responses of Irish vegetation to future climate change. *Biology and Environment: Proceedings of the Royal Irish Academy* 106B(3): 323–34.

- Joosten H. & Clarke D. 2002. *Wise Use of Mires and Peatlands: background and principles including a framework for decision-making*. International Mire Conservation Group / International Peat Society, Finland,
- Joosten H. 2009. *The global peatland CO₂ picture. Peatland status and drainage related emissions in all countries of the world*. [http://www.wetlands.org/WatchRead/Currentpublications/tabid/56/mod/1570/articleType/ArticleView/articleId/2418/The-Global-Peatland-CO₂-Picture.aspx](http://www.wetlands.org/WatchRead/Currentpublications/tabid/56/mod/1570/articleType/ArticleView/articleId/2418/The-Global-Peatland-CO2-Picture.aspx)
- Joosten H. & Couwenberg J. 2009. *Are emission reductions from peatlands MRV-able? Produced for the UN-FCCC meetings in Bonn, June 2009*. Wetlands International. <http://www.wetlands.org/WatchRead/Currentpublications/tabid/56/mod/1570/articleType/ArticleView/articleId/2294/Default.aspx>
- Kasimir-Klemedtsson Å., Klemedtsson L., Berglund K., Martikainen P. J., Silvola J. & Oenema O. 1997. Greenhouse gas emissions from farmed organic soils: a review. *Soil Use and Management* 13: 245–50.
- Kivimäki S. K., Yli-Petäys M. & Tuittila E.-S. 2008. Carbon sink function of sedge and *Sphagnum* patches in a restored cut-away peatland: increased functional diversity leads to higher production. *Journal of Applied Ecology* 45: 921–9.
- Koehler A.-K., Murphy K., Kiely G. & Sottocornola M. 2009. Seasonal variation of DOC concentration and annual loss of DOC from an Atlantic blanket bog in South Western Ireland. *Biogeochemistry*: DOI:10.1007/s10533-009-9333-9.
- Koehler A.-K., Sottocornola M. & Kiely G. 2010. How strong is the current carbon sequestration of an Atlantic blanket bog? *Global Change Biology*: doi:10.1111/j.1365-2486.2010.02180.x.
- Komulainen V.-M., Nykänen H., Martikainen P. J. & Laine J. 1998. Short-term effect of restoration on vegetation change and methane emissions from peatlands drained for forestry in southern Finland. *Canadian Journal of Forest Research* 28: 402–11.
- Komulainen V.-M., Tuittila E.-V., Vasander H. & Laine J. 1999. Restoration of drained peatlands in southern Finland: initial effects on vegetation change and CO₂ balance. *Journal of Applied Ecology* 36: 634–48.
- Lafleur P. M., Roulet N. T. & Admiral S. W. 2001. Annual cycle of CO₂ exchange at a bog peatland. *Journal of Geophysical Research* 106(D3): 3071–81.
- Lafleur P. M., Moore T. R., Roulet N. T. & Frohling S. 2005. Ecosystem respiration in a cool temperate bog depends on peat temperature but not water table. *Ecosystems* 8: 619–29.
- Laine A., Sottocornola M., Kiely G., Byrne K. A., Wilson D. & Tuittila E.-S. 2006. Estimating net ecosystem exchange in a patterned ecosystem: Example from blanket bog. *Agricultural and Forest Meteorology* 138: 231–43.
- Laine A., Byrne K. A., Kiely G. & Tuittila E.-S. 2007a. Patterns in vegetation and CO₂ dynamics along a water level gradient in a lowland blanket bog. *Ecosystems*: doi:10.1007/s10021-007-9067-2.
- Laine A., Wilson D., Kiely G. & Byrne K. A. 2007b. Methane flux dynamics in an Irish lowland blanket bog. *Plant and Soil*: doi 10.1007/s11104-007-9374-6.
- Laine A., Riutta T., Juutinen S., Väiranta M. & Tuittila E.-S. 2009. Acknowledging the spatial heterogeneity in modelling / reconstructing carbon dioxide exchange in a northern aapa mire. *Ecological Modelling* 220: 2646-2655.
- Löffeld N., Flessa H., Augustin J. & Beese F. 1997. Automated gas chromatographic system for rapid analysis of the atmospheric trace gases methane, carbon dioxide and nitrous oxide. *Journal of Environmental Quality* 26: 560–4.
- Lucchese M., Waddington J. M., Poulin M., Pouliot R., Rochefort L. & Strack M. 2010. Organic matter accumulation in a restored peatland: Evaluating restoration success. *Ecological Engineering* 36: 482–8.
- Lund M., Lafleur P. M., Roulet N. T., Lindroth A., Christensen T. R., Aurela M., Chojnicki B., Flanagan L. B., Humphreys E. R., Laurila T., Oechel W. C., Olejnik J., Rinne J., Schubert P. & Nilsson M. B. 2010. Variability in exchange of CO₂ across 12 northern peatland and tundra sites. *Global Change Biology* 16: 2436–48.
- Mäkilä M., Saarnisto M. & Kankainen T. 2001. Aapa mires as a carbon sink and source during the Holocene. *Journal of Ecology* 89: 589–99.
- Malone S. & O'Connell C. 2009. *Ireland's Peatland Conservation Action Plan 2020 - Halting the loss of biodiversity*. Irish Peatland Conservation Council. Lullymore, Co.Kildare, Ireland, pp.151.
- Martikainen P. J., Nykänen H., Alm J. & Silvola J. 1995. Change in fluxes of carbon dioxide, methane and nitrous oxide due to forest drainage of mire sites of different trophic. *Plant and Soil* 167–169: 571–577.
- Matthews E. & Fung I. 1987. Methane emission from natural wetlands: Global distribution, area and environmental characteristics of sources. *Global Biogeochemical Cycles* 1(1): 61–86.
- Mikaloff Fletcher S. E., Tans P. P., Bruhwiler L. M., Miller J. B. & Heimann M. 2004. CH₄ sources from atmospheric observations of CH₄ and its ¹³C/¹²C isotopic ratios: 1. Inverse modelling of source processes. *Global Biogeochemical Cycles* 18: GB4004, doi:10.1029/2004GB002223.

- Moore T. R., Roulet N. T. & Waddington J. M. 1998. Uncertainty in predicting the effect of climatic change on the carbon cycling of Canadian peatlands. *Climatic change* 40: 229–45.
- Motherway B. & Walker N. 2009. *Ireland's low-carbon opportunity. An analysis of the costs and benefits of reducing greenhouse gas emissions*. Analysis carried out by McKinsey & Co for Sustainable Energy Ireland.
- Nieveen J. P., Jacobs C. M. J. & Jacobs A. F. G. 1998. Diurnal and seasonal variation of carbon dioxide exchange from a former true raised bog. *Global Change Biology* 4(8): 823–33.
- Nijkamp P., Vindigni G. & Nunes P. A. L. D. 2008. Economic valuation of biodiversity: A comparative study. *Ecological Economics* 67(2): 217–31.
- Nykänen H., Silvola J., Alm J. & Martikainen P. J. 1996. Fluxes of greenhouse gases CH₄, CO₂ and N₂O on some peat mining areas in Finland. In: Laiho R., Laine J. & Vasander H. (eds.), *Northern peatlands in global climate change. Proceedings of the International Workshop held in Hyytiälä, Finland, 8 - 12 October 1995*. The Academy of Finland, Helsinki, pp. 141–7.
- Nykänen H., Alm J., Silvola J., Tolonen K. & Martikainen P. J. 1998. Methane fluxes on boreal peatlands of different fertility and the effect of long-term experimental lowering of the water table on flux rates. *Global Biogeochemical Cycles* 12(1): 53–69.
- O'Brien P. 2007. *Data analysis and estimation of greenhouse gas emissions and removal for the IPCC sector land use, land use change and forestry sectors in Ireland*. Environmental Research Centre report, Environmental Protection Agency, Johnstown Castle, Co. Wexford, Ireland, pp. 61.
- O'Connell C. 1998. Raised bogs – a priority for conservation. In: O'Leary G. & Gormley F. (eds.), *Towards a conservation strategy for the bogs of Ireland*, Irish Peatland Conservation Council, pp. 43–56.
- Page S. E., Slegert F., Rieley J. O., Boehm H.-D. V., Jaya A. & Limin S. 2002. The amount of carbon released from peat and forest fires in Indonesia during 1997. *Nature* 420: 61–5.
- Parish F., Sirin A., Charman D., Joosten H., Minayeva T., Silvius M. & Stringer I. 2008. *Assessment on peatlands, biodiversity and climate change. Main report*. Global Environment Centre, Kuala Lumpur and Wetlands International, Wageningen
- Penman J., Gytarsky M., Hiraishi T., Krug T., Kruger D., Pipatti R., Buendia L., Miwa K., Ngara T., Tanabe K. & Wagner F. 2003. *Good practice guidance for land use, land use change and forestry*. Published for the IPCC by the Institute for Global Environmental Strategies. Hayama, Japan.
- Price J. 1997. Soil moisture, water tension and water table relationships in a managed cutover bog. *Journal of Hydrology* 202: 21–32.
- Quinty F. & Rochefort L. 2003. *Peatland Restoration Guide*. Canadian Sphagnum Peat Moss Association and New Brunswick Department of Natural Resources and Energy, Québec.
- Reed M. S., Bonn A., Slee W., Beharry-Borg N., Birch J., Brown I., Burt T. P., Chapman D., Chapman P. J., Clay G. D., Cornell S. J., Fraser E. D. G., Glass J. H., Holden J., Hodgson J. A., Hubacek K., Irvine B., Jin N., Kirkby M. J., Kunin W. E., Moore O., Moseley D., Prell C., Price M. F., Quinn C. H., Redpath S., Reid C., Stagl S., Stringer L. C., Termansen M., Thorp S., Towers W. & Worrall F. 2009. The future of the uplands. *Land Use Policy* 26 (Supplement 1): S204–S216.
- Renou-Wilson F., Bolger T., Bullock C., Convery F., Curry J. P., Ward S., Wilson D. & Muller C. 2011. *BOGLAND – A Protocol for the Sustainable Management of Peatlands in Ireland*. ERDTI/STRIVE Report prepared for the Environmental Protection Agency. Johnstown Castle, Co. Wexford.
- Renou F., Egan T. & Wilson D. 2006. Tomorrow's landscapes: studies in the after-uses of industrial cutaway peatlands in Ireland. *Suo* 57(4): 97–107.
- Rieley J. O., Wüst R. A., Jauhiainen J., Page S. E., Wösten H., Hooijer A., Siegert F., Limin S. H., Vasander H. & Stahlhut M. 2008. Tropical peatlands: Carbon stores, carbongas emissions and contribution to climate change processes. In: Strack M. (ed.), *Peatlands and Climate Change*. International Peat Society, Jyväskylä, Finland, pp. 148–81.
- Rinne J., Riutta T., Pihlatie M., Aurela M., Haapanala S., Tuovinen J. & Tuittila E.-S. 2007. Annual cycle of methane emission from a boreal fen measured by the eddy covariance technique. *Tellus*: 1–9.
- Riutta T., Laine J., Aurela M., Rinne J., Vesala T., Laurila T., Haapanala S., Pihlatie M. & Tuittila E.-S. 2007a. Spatial variation in plant community functions regulates carbon gas dynamics in a boreal fen ecosystem. *Tellus* 59B: 838–52.
- Riutta T., Laine J. & Tuittila E.-S. 2007b. Sensitivity of CO₂ exchange of fen ecosystem components to water level variation. *Ecosystems* 10: 718–33.
- Rochefort L., Campeau S. & Bugnon J.-L. 2002. Does prolonged flooding prevent or enhance regeneration and growth of *Sphagnum*? *Aquatic Biology* 74: 327–41.
- Roobroeck D., Butterbach-Bahl K., Brüggemann N. & Boeckx P. 2010. Dinitrogen and nitrous oxide exchanges from an undrained monolith fen: short-term responses following nitrate addition. *European Journal of Soil Science*: 10.1111/j.1365-2389.2010.01269.x.

- Roulet N. T., Moore T., Bubier J. & Lafleur P. M. 1992. Northern fens: methane flux and climatic change. *Tellus* 44B: 100–5.
- Roulet N. T., Lafleur P. M., Richard P. J. H., Moore T., Humphreys E. R. & Bubier J. 2007. Contemporary carbon balance and late Holocene carbon accumulation in a northern peatland. *Global Change Biology* 13: 397–411, doi:10.1111/j.1365-2486.2006.01292.
- Roura-Carol M. & Freeman C. 1999. Methane release from peat soils: effects of *Sphagnum* and *Juncus*. *Soil Biology and Biochemistry* 31: 323–5.
- Saarnio S., Alm J., Silvola J., Lohila A., Nykänen H. & Martikainen P. J. 1997. Seasonal variation in CH₄ emissions and production and oxidation potentials at microsites on an oligotrophic pine fen. *Oecologia* 110: 414–22.
- Saarnio S., Wittenmayer L. & Merbach W. 2004. Rhizospheric exudation of *Eriophorum vaginatum* L. – Potential link to methanogenesis. *Plant and Soil* 267: 343–55.
- Salm J. O., Kimmel K., Uri V. & Mander Ä. 2009. Global warming potential of drained and undrained peatlands in Estonia: a synthesis. *Wetlands* 29(4): 1081–92.
- Salonen V., Penttinen A. & Särkkä A. 1992. Plant colonisation of a bare peat surface: population changes and spatial patterns. *Journal of Vegetation Science* 3: 113–18.
- SBSTA (Subsidiary Body for Scientific and Technological Advice). 2010. *Revision of the UNFCCC reporting guidelines on annual inventories for Parties included in Annex I to the Convention. Thirty Second Session. Agenda item 7(b). Methodological issues under the Convention. Bonn, Germany. 31st May to 9th June 2010.*
- Schils R., Kuikman P., Liski J., van Oijen M., Smith P., Webb J., Alm J., Somogyi Z., van den Akker J., Billet M., Emmett B., Evans C., Lindner M., Palosuo T., Bellamy P., Jandl R. & Hiederer R. 2008. *Review of existing information on the interrelations between soil and climate change. Climsoil Final Report.* http://ec.europa.eu/environment/soil/pdf/climsoil_report_dec_2008.pdf
- Schouten M. G. C. 1998. The cost of management and rehabilitation of peatlands. In: O'Leary G. & Gormley F. (eds.), *Towards a Conservation Strategy for the Bogs of Ireland*. Irish Peatland Conservation Council., pp. 31–42.
- Schouten M. G. C. (ed.) 2002. *Conservation and restoration of raised bogs: geological, hydrological and ecological studies*. Department of the Environmental and Local Government, Staatsbosbeheer.
- Schumann M. & Joosten H. 2008. *Global Peatland Restoration Manual*. Institute of Botany and Landscape Ecology, University of Greifswald, Germany, pp. 64
- Shurpali N. J., Verma S. B., Kim J. & Arkebauer T. J. 1995. Carbon dioxide exchange in a peatland ecosystem. *Journal of Geophysical Research* 100(D7): 14, 319–14, 326.
- Silvan N., Tuittila E.-S., Kitunen V., Vasander H. & Laine J. 2005. Nitrate uptake by *Eriophorum vaginatum* controls N₂O production in a restored peatland. *Soil Biology and Biochemistry* 37(8): 1519–26.
- Silvola J., Alm J., Ahlholm U., Nykänen H. & Martikainen P. J. 1996. CO₂ fluxes from peat in boreal mires under varying temperature and moisture conditions. *Journal of Ecology* 84: 219–28.
- Sjörs H. 1980. Peat on earth: Multiple use or conservation? *Ambio* 9(6): 303–8.
- Soini P., Riutta T., Yli-Petäys M. & Vasander H. 2009. Comparison of vegetation and CO₂ dynamics between a restored cut-way peatland and a pristine fen: evaluation of the restoration success. *Restoration Ecology*: doi:10.1111/j.1526-100X.2009.00520.
- Sottocornola M., Boudreau S. & Rochefort L. 2007. Peat bog restoration: Effect of phosphorus on plant re-establishment. *Ecological Engineering* 31: 29–40.
- Sottocornola M., Laine A., Kiely G., Byrne K. A. & Tuittila E.-S. 2008. Vegetation and environmental variation in an Atlantic blanket bog in south-western Ireland. *Plant Ecology*: DOI: 10.1007/s11258-008-9510-2.
- Sottocornola M. & Kiely G. 2010. Hydro-meteorological controls on the CO₂ exchange variation in an Irish blanket bog. *Agricultural and Forest Meteorology*: doi: 10.1016/j.agrformet.2009.11.013.
- Strack M., Waller M. F. & Waddington J. M. 2006. Sedge succession and peatland methane dynamics: A potential feedback to climate change. *Ecosystems* 9: 278–87.
- Ström L., Ekberg A., Mastepanov M. & Christiansen T. 2003. The effect of vascular plants on carbon turnover and methane emissions from a tundra wetland. *Global Change Biology* 9: 1185–92.
- Sundh I., Nilsson M., Mikkilä C., Granberg G. & Svensson B. H. 2000. Fluxes of methane and carbon dioxide on peat-mining areas in Sweden. *Ambio* 29(8): 499–503.
- Sweeney J., Donnelly A., McElwain L. & Jones M. 2002. *Climate Change. Indicators for Ireland. Final report*. Environmental Protection Agency. Ireland.
- Sweeney J., Albanito F., Brereton A., Caffarra A., Charlton R., Donnelly A., Fealy R., Fitzgerald J., Holden N., Jones M. & Murphy C. 2008. *Climate Change – Refining the Impacts for Ireland*. Strive Report 2001-CD-C3-M1, Prepared for the Environmental Protection Agency by National University Of Ireland, Maynooth.

- The Economics of Ecosystems and Biodiversity (TEEB). 2009. *The economics of ecosystems and biodiversity for national and international policy makers. Summary: Responding to the value of nature 2009*. Welzel and Hardt, Wesseling, Germany. pp.39.
- Tuittila E.-S., Komulainen V.-M., Vasander H. & Laine J. 1999. Restored cut-away peatland as a sink for atmospheric CO₂. *Oecologia* 120: 563–74.
- Tuittila E.-S., Komulainen V.-M., Vasander H., Nykänen H., Martikainen P. J. & Laine J. 2000a. Methane dynamics of a restored cut-away peatland. *Global Change Biology* 6: 569–81.
- Tuittila E.-S., Vasander H. & Laine J. 2000b. Impact of rewetting on the vegetation of a cutaway peatland. *Applied Vegetation Science* 3: 205–12.
- Tuittila E.-S., Vasander H. & Laine J. 2003. Success of re-introduced *Sphagnum* in a cutaway peatland. *Boreal Environment Research* 8: 245–50.
- Tuittila E.-S., Vasander H. & Laine J. 2004. Sensitivity of carbon sequestration in reintroduced *Sphagnum* to water-level variation in a cutaway peatland. *Restoration Ecology* 12: 482–92.
- Turunen J., Tomppo E., Tolonen K. & Reinikainen A. 2002. Estimating carbon accumulation rates of undrained mires in Finland-application to boreal and subarctic regions. *The Holocene* 12(1): 69–80.
- Van Seters T. E. & Price J. S. 2001. The impact of peat harvesting and natural regeneration on the water balance of an abandoned cutover bog, Quebec. *Hydrological Processes* 15: 233–48.
- Vasander H., Tuittila E.-S., Lode E., Lundin L., Ilomets M., Sallantus T., Heikkilä R., Pitkänen M.-L. & Laine J. 2003. Status and restoration of peatlands in northern Europe. *Wetlands Ecology and Management* 11: 51–63.
- Vasander H. & Kettunen A. 2006. Carbon in boreal peatlands. In: Wieder R. K. & Vitt D. H. (eds.), *Ecological Studies, Vol. 188. Boreal Peatland Ecosystems*. Springer-Verlag, Berlin Heidelberg, pp. 165–94.
- Verified Carbon Standard (VCS) Association. 2008. *Verified Carbon Standard – Guidance for Agriculture, Forestry and Other Land Use Projects*. (VCS 2007.1, 2008), www.v-c-s.org. (Date accessed 4.4.2012).
- von Arnold K., Nilsson M., Hånell B., Weslien P., Svensson B. H. & Klemedtsson L. 2005. Fluxes of CO₂, CH₄ and N₂O from drained organic soils in deciduous forests. *Soil Biology & Biochemistry* 37: 1059–71.
- Waddington J. M. & Price J. S. 2000. Effect of peatland drainage, harvesting and restoration on atmospheric water and carbon exchange. *Physical Geography* 21(5): 433–51.
- Waddington J. M., Rotenberg P. A. & Warren F. J. 2001. Peat CO₂ production in a natural and cutover peatland: Implications for restoration. *Biogeochemistry* 54: 115–30.
- Waddington J. M. & Warner K. D. 2001. Atmospheric CO₂ sequestration in restored mined peatlands. *Ecoscience* 8(3): 359–68.
- Waddington J. M., Warner K. D. & Kennedy G. W. 2002. Cutover peatlands: A persistent source of atmospheric CO₂. *Global Biogeochemical Cycles* 16(1): 1002, doi:10.1029/2001GB001398.
- Waddington J. M. & Day S. M. 2007. Methane emissions from a peatland following restoration. *J. Geophysical Research* 112(G3): G03018.
- Waddington J. M., Tóth K. & Bourbonniere R. A. 2008. Dissolved organic carbon export from a cutover and restored peatland. *Hydrological Processes* 22: 2215–24.
- Waddington J. M., Plach J., Cagampan J. P. & Strack M. 2009. Reducing the carbon footprint of Canadian peat extraction and restoration. *Ambio* 38(4): 194–200.
- Waddington J. M., Strack M. & Greenwood M. J. 2010. Toward restoring the net carbon sink function of degraded peatlands: Short-term response in CO₂ exchange to ecosystem-scale restoration. *Journal of Geophysical Research* 115: G01008, doi:10.1029/2009JG001090.
- Walter B. P., Heimann M. & Matthews E. 2001. Modeling modern methane emissions from natural wetlands 1. Model description and results. *J. Geophys. Res.* 106(D24): 34189–206.
- Welker J. M., Fahnestock J. T., Henry G. H. R., O’Shea K. W. & Chimmer R. A. 2004. CO₂ exchange in three Canadian high arctic ecosystems: response to long-term experimental warming. *Global Change Biology* 10: 1981–1995, doi: 10.1111/j.1365-2486.2004.00857.x.
- Wheeler B. D. & Shaw S. C. 1995. *Restoration of damaged peatlands with particular reference to lowland raised bogs affected by peat extraction*. Department of the Environment. University of Sheffield.
- Whiting G. J. & Chanton J. P. 2001. Greenhouse carbon balance of wetlands: methane emission versus carbon sequestration. *Tellus* 53B: 521–8.
- Wilson D., Alm J., Riutta T., Laine J., Byrne K. A., Farrell E. P. & Tuittila E.-S. 2007a. A high resolution green area index for modelling the seasonal dynamics of CO₂ exchange in vascular plant peatland communities. *Plant Ecology* 190: 37–51, DOI 10.1007/s11258-006-9189-1.
- Wilson D., Tuittila E.-S., Alm J., Laine J., Farrell E. P. & Byrne K. A. 2007b. Carbon dioxide dynamics of a restored maritime peatland. *Ecoscience* 14(1): 71–80.

- Wilson D. 2008. Death by a thousand cuts: small scale peat extraction and the Irish peatland carbon store. In: Farrell C. A. & Feehan J. (eds.), *13th International Peat Congress, Tullamore, June 8–13 2008*, International Peat Society, Jyväskylä, Finland, pp. 700–3.
- Wilson D., Alm J., Laine J., Byrne K. A., Farrell E. P. & Tuittila E.-S. 2009. Rewetting of cutaway peatlands: Are we re-creating hotspots of methane emissions? *Restoration Ecology* 17(6): 796–806 doi: 10.1111/j.1526-100x.2008.00416.x.
- Wind-Mulder H. L., Rochefort L. & Vitt D. H. 1996. Water and peat chemistry comparisons of natural and post-harvested peatlands across Canada and their relevance to peatland restoration. *Ecological Engineering* 7: 161–81.
- Worrall F., Reed M., Warburton J. & Burt T. 2003. Carbon budget for a British upland peat catchment. *The Science of the Total Environment*. 312: 133–46.
- Worrall F. & Burt T. 2005. Predicting the future DOC flux from upland peat catchments. *Journal of Hydrology* 300: 126–39.
- Worrall F., Burt T. P., Rowson J. G., Warburton J. & Adamson J. K. 2009a. The multi-annual carbon budget of a peat-covered catchment. *Science of the Total Environment* 407(13): 4084–94.
- Worrall F., Evans M. G., Bonn A., Reed M. S., Chapman D. & Holden J. 2009b. Can carbon offsetting pay for upland ecological restoration? *Science of the Total Environment* 408: 26–36.
- Yli-Petäys M., Laine J., Vasander H. & Tuittila E.-S. 2007. Carbon gas exchange of a re-vegetated cut-away peatland five decades after abandonment. *Boreal Environment Research* 12: 177–90.

Acronyms and Annotations

CH ₄	Methane
CO ₂	Carbon dioxide
DOC	Dissolved organic carbon
EU ETS	European Union Emissions Trading Scheme
GAI	Green area index
GHG	Greenhouse gas
GWP	Global warming potential
IPCC	Intergovernmental Panel for Climate Change
LULUCF	Land use, land use change and forestry
N ₂ O	Nitrous oxide
NEE	Net ecosystem exchange
P _G	Gross photosynthesis
POC	Particulate organic carbon
PPFD	Photosynthetic photon flux density
PRC	Peatland Rewetting and Conservation
r ²	coefficient of determination
R _{ECO}	Ecosystem respiration
SBSTA	Subsidiary Body for Scientific and Technological Advice
Tg	Terragrams
UNFCCC	United Nations Framework Convention on Climate Change
VCS	Voluntary Carbon Standard
WT	Water table
WTD	Water table depth

An Ghníomhaireacht um Chaomhnú Comhshaoil

Is í an Ghníomhaireacht um Chaomhnú Comhshaoil (EPA) comhlachta reachtúil a chosnaíonn an comhshaoil do mhuintir na tíre go léir. Rialaímid agus déanaimid maoirsiú ar ghníomhaíochtaí a d'fhéadfadh truailliú a chruthú murach sin. Cinntímid go bhfuil eolas cruinn ann ar threochtaí comhshaoil ionas go nglactar aon chéim is gá. Is iad na príomhnithe a bhfuilimid gníomhach leo ná comhshaoil na hÉireann a chosaint agus cinntiú go bhfuil forbairt inbhuanaithe.

Is comhlacht poiblí neamhspleách í an Ghníomhaireacht um Chaomhnú Comhshaoil (EPA) a bunaíodh i mí Iúil 1993 faoin Acht fán nGníomhaireacht um Chaomhnú Comhshaoil 1992. Ó thaobh an Rialtais, is í an Roinn Comhshaoil, Pobal agus Rialtais Áitiúil.

ÁR bhFREAGRACHTAÍ

CEADÚNÚ

Bíonn ceadúnais á n-eisiúint againn i gcomhair na nithe seo a leanas chun a chinntiú nach mbíonn astuithe uathu ag cur sláinte an phobail ná an comhshaoil i mbaol:

- áiseanna dramhaíola (m.sh., líonadh talún, loisceoirí, stáisiúin aistriúcháin dramhaíola);
- gníomhaíochtaí tionsclaíocha ar scála mór (m.sh., déantúsaíocht cógaisíochta, déantúsaíocht stroighne, stáisiúin chumhachta);
- diantalmhaíocht;
- úsáid faoi shrian agus scaoileadh smachtaithe Orgánach Géinathraithe (GMO);
- mór-áiseanna stórais peitreal;
- scardadh dramhuisce.

FEIDHMIÚ COMHSHAOIL NÁISIÚNTA

- Stiúradh os cionn 2,000 iniúchadh agus cigireacht de áiseanna a fuair ceadúnas ón nGníomhaireacht gach bliain.
- Maoirsiú freagrachtaí cosanta comhshaoil údarás áitiúla thar sé earnáil - aer, fuaim, dramhaíl, dramhuisce agus caighdeán uisce.
- Obair le húdaráis áitiúla agus leis na Gardaí chun stop a chur le gníomhaíocht mhídhleathach dramhaíola trí chomhordú a dhéanamh ar líonra forfheidhmithe náisiúnta, díriú isteach ar chiontóirí, stiúradh fiosrúcháin agus maoirsiú leigheas na bhfadhbanna.
- An dlí a chur orthu siúd a bhriseann dlí comhshaoil agus a dhéanann dochar don chomhshaoil mar thoradh ar a ngníomhaíochtaí.

MONATÓIREACHT, ANAILÍS AGUS TUAIRISCIÚ AR AN GCOMHSHAOIL

- Monatóireacht ar chaighdeán aer agus caighdeán aibhneacha, locha, uisce taoide agus uisce talaimh; leibhéil agus sruth aibhneacha a thomhas.
- Tuairisciú neamhspleách chun cabhrú le rialtais náisiúnta agus áitiúla cinntiú a dhéanamh.

RIALÚ ASTUITHE GÁIS CEAPTHA TEASA NA HÉIREANN

- Caimníochtú astuithe gáis ceaptha teasa na hÉireann i gcomhthéacs ár dtiomantas Kyoto.
- Cur i bhfeidhm na Treorach um Thrádáil Astuithe, a bhfuil baint aige le hos cionn 100 cuideachta atá ina mór-ghineadóirí dé-ocsaíd charbóin in Éirinn.

TAIGHDE AGUS FORBAIRT COMHSHAOIL

- Taighde ar shaincheisteanna comhshaoil a chomhordú (cosúil le caighdeán aer agus uisce, athrú aeráide, bithéagsúlacht, teicneolaíochtaí comhshaoil).

MEASÚNÚ STRAITÉISEACH COMHSHAOIL

- Ag déanamh measúnú ar thionchar phleananna agus chláracha ar chomhshaoil na hÉireann (cosúil le pleananna bainistíochta dramhaíola agus forbartha).

PLEANÁIL, OIDEACHAS AGUS TREOIR CHOMHSHAOIL

- Treoir a thabhairt don phobal agus do thionscal ar cheisteanna comhshaoil éagsúla (m.sh., iarratais ar cheadúnais, seachaint dramhaíola agus rialacháin chomhshaoil).
- Eolas níos fearr ar an gcomhshaoil a scaipeadh (trí cláracha teilifíse comhshaoil agus pacáistí acmhainne do bhunscoileanna agus do mheánscoileanna).

BAINISTÍOCHT DRAMHAÍOLA FHORGHNÍOMHACH

- Cur chun cinn seachaint agus laghdú dramhaíola trí chomhordú An Chláir Náisiúnta um Chosc Dramhaíola, lena n-áirítear cur i bhfeidhm na dTionscnamh Freagrachta Táirgeoirí.
- Cur i bhfeidhm Rialachán ar nós na treoracha maidir le Trealamh Leictreach agus Leictreonach Caite agus le Srianadh Substaintí Guaiseacha agus substaintí a dhéanann ídiú ar an gcrios ózón.
- Plean Náisiúnta Bainistíochta um Dramhaíl Ghuaiseach a fhorbairt chun dramhaíl ghuaiseach a sheachaint agus a bhainistiú.

STRUCHTÚR NA GNÍOMHAIREACHTA

Bunaíodh an Ghníomhaireacht i 1993 chun comhshaoil na hÉireann a chosaint. Tá an eagraíocht á bhainistiú ag Bord lánaimseartha, ar a bhfuil Príomhstíúrthóir agus ceithre Stíúrthóir.

Tá obair na Ghníomhaireachta ar siúl trí ceithre Oifig:

- An Oifig Aeráide, Ceadúnaithe agus Úsáide Acmhainní
- An Oifig um Fhorfheidhmiúchán Comhshaoil
- An Oifig um Measúnacht Comhshaoil
- An Oifig Cumarsáide agus Seirbhísí Corparáide

Tá Coiste Chomhairleach ag an nGníomhaireacht le cabhrú léi. Tá dáréag ball air agus tagann siad le chéile cúpla uair in aghaidh na bliana le plé a dhéanamh ar cheisteanna ar ábhar imní iad agus le comhairle a thabhairt don Bhord.



Climate Change Research Programme (CCRP) 2007-2013

The EPA has taken a leading role in the development of the CCRP structure with the co-operation of key state agencies and government departments. The programme is structured according to four linked thematic areas with a strong cross cutting emphasis.

Research being carried out ranges from fundamental process studies to the provision of high-level analysis of policy options.

For further information see
www.epa.ie/whatwedo/climate/climatechangeresearch



ENVIRONMENTAL PROTECTION AGENCY
PO Box 3000, Johnstown Castle Estate, Co. Wexford, Ireland
t 053 916 0600 f 053 916 0699
LoCall 1890 33 55 99
e info@epa.ie w <http://www.epa.ie>



Comhshaoil, Pobal agus Rialtas Áitiúil
Environment, Community and Local Government